



ComPac® I & ComPac® II 1 to 6 Ton Vertical Wall Mount Air Conditioners

R-410A
Refrigerant

Models AVPA12-24-30-36-42-48-60-72 (Single Stage Compressor)
Models HVEA24-30-36-42-49-60 (Single Stage Compressor)
Models HVESA36-42-49-60 (2-Stage Compressor)

General Description

The Marvair® ComPac® I and ComPac® II air conditioners are used primarily to cool electronic and communication equipment shelters. Due to the high internal heat load, these shelters require cooling even when outside temperatures drop below 60°F (15°C). The ComPac I and ComPac II air conditioners have the necessary controls and components for operation during these (less than 60°F [15°C]) temperatures. All models use the non-ozone depleting R-410A refrigerant.

The primary difference between the ComPac I and the ComPac II units is that the ComPac® II air conditioner has a factory installed economizer. When cool and dry, the economizer uses outside air to cool the shelter. The economizer provides temperature control, energy cost savings, and increased reliability by decreasing the operating hours of the compressor and the condenser fan. The ComPac I and ComPac II air conditioners are problem solvers for a wide range of conditions and applications. To insure proper operation and optimum performance, all economizers are non-removable, factory installed and tested. In addition, factory and field installed accessories can be used to meet specific requirements.

The HVEA and HVESA models are Marvair's most efficient wall mount air conditioners. Electronically commutated indoor fan motors combined with highly efficient scroll compressors result in Energy Efficiency Ratios (EER's) of up to 11.75.

Models HVESA36-42-49-60 have a 2-stage compressor with first stage cooling approximately 65% of the total cooling capacity. The 2-stage compressor provides lower start-up amps which can be critical when operating with a generator. The two stage compressor can also reduce energy costs and is able to more precisely match the cooling capacity of the air conditioner with the heat load in the shelter. Both ComPac I and ComPac II units are available with 2 stage compressors.



AVPA36ACA-100C



Safety Listed and Energy Certified

All ComPac air conditioners are built to UL standard 1995, 3rd edition and CAN/CSA C22.2, No. 236-11, 3rd edition. For energy efficiency and performance, the units are tested and rated in accordance to the ANSI/ARI (Air-Conditioning and Refrigeration Institute) Standard 390- 2003 (Single Package Vertical Units). All units meet or exceed the efficiency requirements of ANSI/ASHRAE/IESNA 90.1.2007. The ComPac I and ComPac II air conditioners are commercial units and are not intended for use in residential applications.

*ComPac® II air conditioner only

Standard Features

Designed for Operation in Low Ambient Conditions

- Low ambient control cycles condenser fan to maintain proper refrigerant pressures. Allows operation in mechanical cooling (compressor) of our standard air conditioners down to 20°F (-7°C). With the Extreme Duty option, the units will operate down to 0°F (-18°C). Note: low temperature operation is affected by ambient conditions, e.g. wind and humidity.
- Three minute by-pass of the low pressure switch for start-up of compressor when outdoor temperatures are below 55°F (13°C).
- Factory built-in economizer.*

High Efficiency

- High efficiency compressor.
- Lanced fins standard on all evaporator and condenser coils.

Built-in Reliability

- High pressure switch and low pressure switch with lockout protects refrigerant circuit.
- Adjustable .03 to ten minute delay on make for short cycle protection.

Remote Alarm Capability

- Dry contacts can be used for remote alarm or notification upon air conditioner lockout.

Ease of Installation

- Sloped top with flashing eliminates need of rainhood.
- Built-in mounting flanges facilitate installation and minimize chance of water leaks.
- Supply and return openings exactly match previous models.
- Factory installed disconnect on all units.
- Single Point Power Entry complies with latest edition of U.L. Standard 1995.

Rugged Construction

- Copper tube, aluminum fin evaporator & condenser coils.
- Field or factory installed heaters on discharge side of evaporator coil (optional)
- Baked on neutral beige finish over galvanneal steel for maximum cabinet life. (Other finishes are available.)

Ease of Service

- Service access valves are standard.
- Standard 2" (50 mm) pleated filter with a MERV rating of 7 changeable from outside.
- All major components are readily accessible.
- Front Control Panel allows easy access and complies with NEC clearance codes on redundant side-by-side systems.
- LEDs indicate operational status and fault conditions.
- Foiled backed insulation on the indoor air path.
- A minimum position potentiometer that can be adjusted to prevent the economizer damper from closing completely. This control ensures that whenever the evaporator fan is operating, fresh air is being introduced into the building.

*ComPac® II air conditioner only

A Marvair® First – Factory Installed Economizer

Marvair's ComPac® II air conditioner has been the industry standard since its introduction in 1986. Tens of thousands of ComPac II air conditioners are in operation from the metropolitan areas of North America to the deserts of the Mid-East to the Siberian tundra. Here's how the economizer works:

On a signal from the wall mounted indoor thermostat that cooling is required, either mechanical cooling with the compressor or free cooling with the economizer is provided. A factory installed enthalpy controller determines whether the outside air is sufficiently cool and dry to be used for cooling. If suitable, the compressor is locked out and the economizer damper opens to bring in outside air. Integral pressure relief allows the interior air to exit the shelter, permitting outside air to enter the shelter. The temperature at which the economizer opens is adjustable from 63°F (17°C) at 50% Relative Humidity to 73°F (23°C) at 50% Relative Humidity.

After the enthalpy control has activated and outside air is being brought into the building, the mixed air sensor measures the temperature of the air entering the indoor blower and then modulates the economizer damper to mix the right proportion of cool outside air with warm indoor air to maintain 50-63°F (10 - 17°C) air being delivered to the building. This prevents shocking the electronic components with cold outside air. The compressor is not permitted to operate when the economizer is functioning.

If the outside air becomes too hot or humid, the economizer damper closes completely, or to a minimum open position with an optional minimum position potentiometer, and mechanical cooling is activated.

In all ComPac II air conditioners, the supply air flow in the economizer mode is the same or greater than the rated air flow. (The rated air flow is the AHRI certified air flow when the unit is in mechanical cooling.) The "full flow" economizer reduces electrical costs by maximizing the use of outside air for cooling.

Savings with an Economizer

The following table shows the annual electrical cost of cooling a 10 ft. x 20 ft. x 9 ft. (3m x 6m x 2.7m) shelter in nine cities in the US. Costs are shown for an air conditioner without an economizer (ComPac I units), for an air conditioner with an economizer (ComPac II units) and the savings. The savings do not include any demand charges. The savings are based on the electrical usage of a five ton air conditioner and an electric rate of \$.10 per kilowatt-hour, the approximate average commercial rate in the US.

Hours of Operation	Atlanta, GA	Boston, MA	Chicago, IL	Dallas, TX	Denver, CO	Houston, TX
Annual Compressor & Condenser Motor Run Time without Economizer (Hrs.)	6,531	6,348	6,361	6,628	6,472	6,655
Annual Compressor & Condenser Motor Run Time with Economizer (Hrs.)	3,841	2,153	2,424	3,798	750	4,970
Run Time Savings with the Economizer (Hrs.)	2,690	4,195	3,937	2,830	5,722	1,685
Annual Costs Saving (\$) of 9.0 EER unit with an Economizer (ComPac II)						
Annual Operating Cost 9.0 EER Unit without Economizer (\$)	\$4,100.00	\$3,985.00	\$4,792.00	\$4,161.00	\$3,657.00	\$4,178.00
Annual Operating Cost 9.0 EER with Economizer	\$2,685.00	\$1,784.00	\$2,315.00	\$2,671.00	\$940.00	\$3,291.00
Annual Savings using 9.0 EER Unit with Economizer	\$1,415.00	\$2,201.00	\$2,477.00	\$1,490.00	\$2,717.00	\$887.00

Hours of Operation	Los Angeles, CA	Miami, FL	Phoenix, AZ	Pittsburgh, PA	Seattle, WA	St. Louis, MO
Annual Compressor & Condenser Motor Run Time without Economizer (Hrs.)	6,467	6,779	6,765	6,386	6,465	6,472
Annual Compressor & Condenser Motor Run Time with Economizer (Hrs.)	3,862	6,391	3,106	1,929	1,654	2,716
Run Time Savings with the Economizer (Hrs.)	2,605	388	3,659	4,457	4,811	3,756
Annual Costs Saving (\$) of 9.0 EER unit with an Economizer (ComPac II)						
Annual Operating Cost 9.0 EER Unit without Economizer (\$)	\$4,060.00	\$4,255.00	\$4,247.00	\$4,009.00	\$3,653.00	\$4,063.00
Annual Operating Cost 9.0 EER with Economizer	\$2,686.00	\$4,051.00	\$2,315.00	\$1,667.00	\$1,368.00	\$2,090.00
Annual Savings using 9.0 EER Unit with Economizer	\$1,374.00	\$204.00	\$1,932.00	\$2,342.00	\$2,285.00	\$1,973.00

Shelter Metrics:

- 10' x 20' x 9' building
- Internal heat gain (electronics load): 12,000 watts.
- Building surface area (excluding floor area): 740 ft²
- R-Value of walls and ceiling: R-12
- Internal shelter temperature (Thermostat set point): 75°F

Air Conditioner Metrics:

- ComPac II Economizer setting: 57°F (wet bulb)
- A/C unit capacity: 60,000 BTUH (5 tons) with 1-stage compressor
- Nominal EER (unit efficiency): 9.0 (models AVPA)
- Cost of power: \$.10 per KWH

Operation of the 2-Stage Compressor Air Conditioners with a CommStat 4™ Lead/Lag Thermostat Controller

Marvair's HVESA air conditioners have 2-stage compressors. These units can provide substantial energy savings and better control of temperature and humidity by matching the cooling requirement with the performance of the air conditioner. First stage is typically 65% of the total (2-stage) capacity of the air conditioner. When operated from power supplied by a generator, starting the air conditioner in 1-stage means lower start-up amps.

When two, 2-stage air conditioners are controlled by a CommStat 4 lead/lag controller in a redundant application, one of the air conditioners is the lead unit and the second is the lag unit. On a call for cooling, the lead unit starts operation in the 1-stage (low capacity). If the temperature in the building continues to rise above the set point temperature, the 1-stage (low capacity) of the lag unit will be initiated. When the temperature in the building drops to the set point, the air conditioners will turn off. On a subsequent call for cooling the process will repeat.

If the set point temperature is not reached with 1-stage capacity operation of both air conditioners after approximately six minutes (this time period is field adjustable), the lead air conditioner will commence operation in 2-stage (full capacity). If the temperature in the building continues to rise past the setpoint, the lag unit will switch to 2-stage cooling approximately six minutes (field adjustable) after it began operation. At that time, both air conditioners are operating in maximum capacity.

When the temperature in the building is satisfied, both units will turn off.

If the units have economizers (ComPac II air conditioners), the enthalpy sensor determines whether to use outside air or use mechanical cooling. When the economizer is used, the compressors do not operate.

Marvair's AVPA12 One Ton Air Conditioner – Ideal Replacement for Old Window Air Conditioners or New Construction

The electronic/communication shelter requires cooling virtually year-round because of the heat load generated by the internal electronic equipment (i.e., switching and transmission gear). Residential window room air conditioners are not designed to operate when outside air temperatures are moderate to cold, i.e., below 65°F (18°C). Typical problems are freezing of the coil, diminished capacity and compressor damage which all contribute to high maintenance and short operating life.

The Marvair® One Ton ComPac® I and ComPac® II air conditioners are designed for the electronic/ communication shelter to provide a commercial grade air conditioner for years of operation.

The Marvair One Ton is built to operate continuously and efficiently in a variety of outside conditions. For existing shelters with window air conditioners, upgrading to the commercial grade Marvair air conditioners is made easy by the design of the One Ton ComPac II unit with the factory installed economizer. The back panel is designed for either a 19" x 19" (483 mm x 483 mm) or 28" x 19" (711 mm x 483 mm) opening, standard opening sizes for many window units. The unit is shipped from the factory for mounting on a 19" x 19" (483 mm x 483 mm) opening, but can be easily changed at site to fit in a 28" x 19" (711 mm x 483 mm) opening. With the built-in mounting flanges, the air conditioner mounts quickly and simply to the exterior of the building. The single piece supply and return grille attaches easily to the wall sleeve to complete the installation. The ComPac I (non-economizer) unit has separate supply and return grilles. (See the Accessories section for the part numbers of the grilles and wall sleeves). Factory installed electric heat is available in the Marvair One Ton Air Conditioner thus eliminating baseboard heat and a second power source.

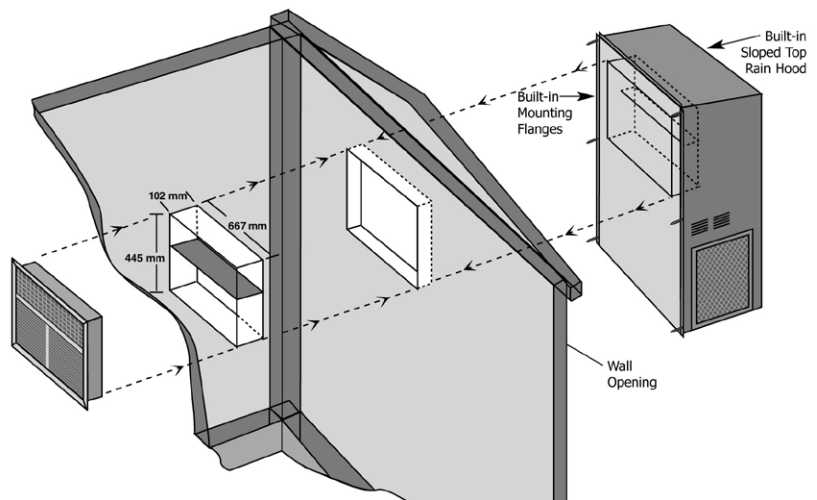

Controllers and Thermostats

Controllers

CommStat 4 Telecom HVAC Controller
P/N S/7846

The CommStat 4 HVAC controller is designed specifically for controlling two redundant air conditioners, heat pumps or air conditioners with 2-stage compressors in a telecommunication shelter. The CommStat 4 has seven outputs for remote alarms or notification. Status LED's indicate HEAT, COOL, POWER and the LEAD unit. When a fault is detected, an alarm LED flashes and the LCD screen displays the fault.

The CommStat 4 uses RS-485 communications via a RJ11 jack. It can be daisy chained with a second CommStat 4 controllers for controlling up to four air conditioners in one shelter. When two CommStat 4 controllers are daisy chained together, one is the MASTER and the other controller is the SLAVE. Any settings to the MASTER unit immediately take effect on the SLAVE unit. See the CommStat 4 Product Data Sheet for complete details.

CommStat3™ Lead/Lag Microprocessor Controller
P/N S/04581

Solid state controller designed to operate a fully or partially redundant air conditioning system. Insures equal wear on both air conditioners while allowing the lag unit to assist upon demand. Lead/

lag changeover is factory set at 7 days, but is field programmable in 1/2 day increments from 1/2 to 7 days. The CommStat 3™ Controller has LED's to indicate status & function, digital display of temperature, a comfort override button for energy savings, five alarm relays, a built in temperature sensor and is fully programmable. See CommStat 3™ Controller Product Data Sheet for details on operation & installation.

LL357D4 Lead/Lag Controller

Two stage heat and cool thermostat with solid state module for redundant operation. (See the LL357D4 Product Data Sheet for details.)

Thermostats & Thermostat Guards

Note: All air conditioners with 2-stage compressors, models HVEVA, require a 2 stage cooling thermostat.
Thermostat P/N 50123

Digital thermostat. 1 stage heat, 1 stage cool. 7 day programmable. Fan switch: Auto & On. Auto-change over. Keypad lockout. Non-volatile program memory.

Thermostat P/N 50107

Digital thermostat. 2 stage heat, 2 stage cool. 7 day programmable. Fan switch: Auto & On. Auto-change over. Status LED's. Backlit display. Programmable fan. Non-volatile program memory.

Thermostat Guard P/N 50092

Thermostat guard for use with the 50123 and 50107 thermostats.

Thermostat P/N 50218

Digital, non-programmable thermostat. 1 stage cool and 1 stage heat. Auto-changeover.

Digital Humidistat P/N 50254

To be used with units with hot gas or electric

reheat. Programmable dehumidistat and ventilation controller. Permanent memory retention of set points. Humidity sensor can be field calibrated. High & low dehumidification set points. Outdoor temperature and humidity sensor included. °F or °C selectable.

Thermostat P/N 50252

Non-programmable digital thermostat with backlit display. 2 stage heat and 2 stage cool. Auto changeover.

Accessories

Supply Grilles

- For AVPA24
20" x 8" (508 mm x 203 mm) P/N 80674
- For AVPA30,36 and HVEA24
28" x 8" (711 mm x 203 mm) P/N 80675
- For AVPA42,48,60,72 and HVEA30, 36, 42, 49, 60
30" x 10" (762 mm x 254 mm) P/N 80676

Return Grilles

- For AVPA12 (non-economizer unit)
17" x 10" (432 mm x 25) P/N 92352
- For AVPA24
20" x 12" (508 mm x 305 mm) P/N 80677
- For AVPA30,36 and HVEA24
28" x 14" (711 mm x 356 mm) P/N 80678
- For AVPA42,48,60,72 and HVEA30, 36, 42, 49, 60
30" x 16" (762 mm x 406 mm) P/N 80679

Return Filter Grilles

Used when filter must be changed from the interior. Not recommended for ComPac® II air conditioner. Note: Filter used in Return Filter Grille is 1" (25 mm) thick.

- For AVPA24
20" x 12" (508 mm x 305 mm) P/N 80671
- For AVPA30,36 and HVEA24
28" x 14" (711 mm x 356 mm) P/N 80672
- For AVPA42,48,60,72 and HVEA30, 36, 42, 49, 60
30" x 16" (762 mm x 406 mm) P/N 80673

AVPA12 Grilles and Wall Sleeves

For AVPA12 ComPac I (non-economizer) Supply Grille 17" x 5" (432 mm x 127 mm) P/N 80682

For AVPA12 ComPac I (non-economizer) unit Return Grille 17" x 10" (432 mm x 25) P/N 80683

For AVPA12 ComPac II (economizer) unit Combination Supply & Return Grilles 17' x 17" (432mm x 432mm) for 19" x 19" (483mm x 483mm) wall opening P/N 92379
26" x 17" (660 mm x 432 mm) for 28" x 19" (711 mm x 483 mm) wall opening P/N80681

Wall Sleeves (A wall sleeve is required for the AVPA12 ComPac II (economizer)

Wall sleeve for 19" x 19" (483 mm x 483 mm) opening P/N S/09392

Wall Sleeve for 28" x 19" (711 mm x 483 mm) opening P/N S/01784



Security Cages.

Deters theft of the air conditioner and components. Constructed of 1" by 11 gauge square tube and 3/4", #9 expanded metal. Hinges and latch are made from steel plate. The complete cage is powder coated for longevity and to match the color of Marvail air conditioners. Field installed.

Options

The ComPac® I and ComPac® II air conditioners were designed and are built to stringent requirements of the communications/electronic shelter. Applications occur that have special requirements. Numerous options are available for the ComPac I and ComPac II air conditioners that meet these special needs.

Hard Start Kit - Used on single phase equipment to give the compressor higher starting torque under low voltage conditions. (Field installed only) (Note: Not recommended for use on scroll compressors.)

Dehumidification – ComPac® I and ComPac® II A/C – Allows the electric heat to operate simultaneously with cooling. See Dehumidification Application Bulletin for details. Note: The electrical characteristics and requirements of air conditioners with the dehumidification option are different from standard

air conditioners. Refer to the appropriate Summary Rating Charts for the electrical characteristics of units with Electric Reheat. Available on all units except the AVPA12

Coastal Environment Package – ComPac® I A/C only – Recommended for units to be installed near an ocean or on seacoast. Includes corrosion resistant fasteners, sealed or partially sealed condenser fan motor, protective coating applied to all exposed internal copper and metal in the in the condenser section and an impregnated polyurethane on the condenser coil. See Coastal Environmental Technical Bulletin for more details. NOTE: The AVPA12 is available with the protective coatings and corrosion resistant fasteners, but does not have a sealed condenser fan motor.

External Low Noise Blower (ELNB) – ComPac® I and ComPac® II A/C – A field installed kit that consists of a condenser air hood, centrifugal blowers, controls and a compressor jacket to reduce the sound level by up to 6 dbA of Marvair ComPac air conditioners. Available for models AVP30-60. See External Low Noise Blower Product Data Sheet for details.

ComPac® II Air Conditioner Transition Curb – ComPac II A/C only – A sheet metal curb that enables a 3-1/2, 4 or 5 ton ComPac II air conditioner to replace a 2-1/2 or 3 ton ComPac II unit. Curb transitions supply and return openings of the 3-1/2, 4 and 5 ton units to the smaller openings.

Hot Gas By-Pass – ComPac® I A/C Only – Used in specialty applications; i.e., Magnetic Resonance Imaging (MRI) buildings, to prevent magnetic voltage disturbance caused by compressor cycling. Hot gas by-pass option packages are available to allow operation to 20°F (-7°C). Please refer to Hot Gas By-pass Application Bulletin for details. Not available on the AVPA12, 20 & 24.

High Filtration – Units are built with larger blowers/motors for use with higher efficiency filters with MERV ratings of 11, 13 and 14 when tested to ASHRAE 52.2. Units with economizers have a prefilter on the outside air. Not available on the AVPA12.

Color - ComPac® I and ComPac® II air conditioners are available in five different cabinet colors -the standard Marvair® beige, white, gray, brown and dark bronze. The standard cabinet's sides, top and front panels are constructed of 20 gauge painted steel. As an option, these panels can be built of 16 gauge steel in beige & gray or .050 stucco aluminum. When the 16 gauge painted steel or the aluminum is used, only the side, top and front panels are 16 gauge or aluminum. Contact your Marvair representative for color chips. The cabinet can also be constructed of type 316 stainless steel. Two stainless steel cabinet constructions are available-the complete cabinet, including most internal sheet metal or only the exterior sheet metal.

Protective Coil Coatings - Either the condenser or evaporator coil can be coated, however, coating of the evaporator coil is not common. For harsh conditions, e.g., power plants, paper mills or sites where the unit will be exposed to salt water, the coil should be coated. Note: Cooling capacity may be reduced by up to 5% on units with coated coils.

Extended Warranty - A first year labor - Silver, and a two year labor - Gold, are available.

Dirty Filter Indicator - A factory installed option that measures the difference in pressure across the internal filter and illuminates a LED when the pressure exceeds the desired difference. Not available on the AVPA12.

Phase Monitor - Monitors 3Ø power supply and will turn the air conditioner off if power supply is not phased properly. Not required on 1Ø units.

Thermal Expansion Valve - Available on all ComPac air conditioners. Improves performance in hot ambient temperatures.

Sealed Condenser Fan Motors - Recommended on units to be installed in corrosive sites, e.g., near the ocean and in deserts with blowing sand. Available on all units except the AVPA12.

Compressor Sound Jacket - To reduce sound of compressor. Available on all units except the AVPA12

Extreme Duty Package (Not Available on AVPA12) - Allows Marvair® air conditioners to operate in extremely cold and hot ambient conditions. The Extreme Duty Kit is always factory installed and is available on all air conditioners. ComPac I units without an economizer will operate from 0°F to 131°F (-18° to 55°C). ComPac II units with an economizer will operate from -20°F to 131°F (-29° to 55°C).

The Extreme Duty Package includes a suction line accumulator, thermal expansion valve (TXV), crankcase heater, hard start kit, an auto reset high pressure switch and an outdoor thermostat and fan cycle switch. The fan cycle control is standard on all ComPac air conditioners and operates based upon the liquid line pressure. The outdoor thermostat opens whenever the outside temperature is below 50°F (10°C) and closes when the outside temperature is 50°F (10°C) or higher. Whenever the temperature is below 50°F (10°C), the fan cycle switch is in the circuit; when temperatures are 50°F (10°C) or higher, the fan cycle switch is not in the circuit. The outdoor thermostat is used with a TXV to prevent excessive cycling or "hunting" of the TXV.

Lockable Disconnect Access Cover Plate - The access plate to the service disconnect switch can be equipped with a lockable cover.

Desert Duty Package (Not available on the AVPA12) – Our standard air conditioners will operate in outside ambient temperatures up to 120°F (48.9°C) The Desert Duty package is a factory installed package of components and cabinet modifications to allow operation in ambient temperatures up to 131°F (55°C). Standard features of the Desert Duty package include a thermal expansion valve and a sealed condenser fan motor. Cabinet modifications include a slotted panel in the base pan that improves condenser air flow and also provides access to the compressor and condenser fan motor. To prevent sand and dust infiltration, the electrical control box is sealed. A closed loop design on the ComPac I unit insures that no outside air is introduced into the shelter. Note: the ComPac II unit with the economizer may be ordered with the Desert Duty Package. If the ComPac II air conditioner is required with the Desert Duty Package, sand intrusion into the shelter should be considered.

Back panel adapters for AVPA60 air conditioners

These back panel adapters are factory installed on the AVPA60 ComPac I air conditioners and to match the supply and return air openings on Marvair 2 and 3 ton air conditioners. This allows the AVPA60 to be quickly and easily installed. No cutting or sawing of the shelter is required. The back panel, K/04317 has supply and return openings that match the openings of AVP24 & AVPA24 wall mounted air conditioners. The back panel, K/04315, has supply and return openings that match the openings of Marvair's AVP36 & AVPA36 air conditioners. In addition to matching the openings of Marvair units, the back panels will also match the openings of other brands.

When the K/04317 back panel adapter is used, a return filter grille, p/n 80671, must be used. When the K/04315 back panel adapter is used, a return filter grille, p/n 80672, must be used.

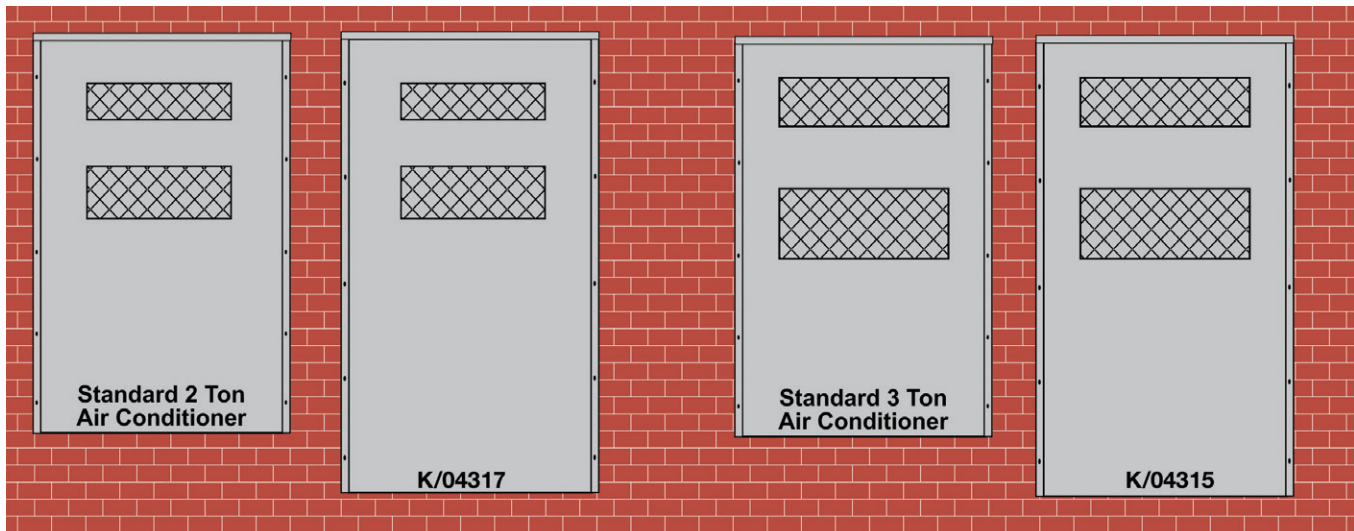

Control Box

The internal control board in the ComPac® air conditioners simplifies wiring, consolidates several of the electrical functions onto one device and improves the reliability of the air conditioner. In addition, the control board has LED's that indicate operational status and fault conditions.

LED Indicator Lights

COLOR	TYPE	STATUS	DESCRIPTION
Green	Power	Constant On	24 VAC power has been applied
Red	Status	Constant On	Normal operation
		1 Blink	High pressure switch has opened twice
		2 Blinks	Low pressure switch has opened twice
		3 Blinks	Freeze stat (optional) - indoor coil temperature is below 35°F (1°C)

Modes of Operation

Normal Start-up: On a call for cooling, and the with the high pressure switch closed, the cooling system (compressor, indoor blower motor and outdoor fan motor) will be energized. (Note: See the Delay on Make feature). The cooling system will remain energized during the three minute low pressure switch bypass cycle. If the low pressure is closed, the cooling system will continue to operate after the three-minute bypass. If the low pressure switch is open after the three-minute bypass, the cooling system will be de-energized.

Lockout Mode: If either the high or low pressure switch opens twice on the same call for cooling, the control board enters into and indicates the lockout mode. In the lockout mode, the compressor is turned off, the alarm output is energized and the status LED's will blink to indicate which fault has occurred. If there is a call for air flow, the indoor blower will remain energized. When the lockout condition has cleared, the unit will reset if the demand of the thermostat is removed or when power is reset. The lockout circuit is factory wired for normally open contacts. The user can select either normally closed or normally open remote alarm dry contacts.

Delay on Make: On initial power up or on resumption of power, the air conditioner will wait .03 to 10 minutes from a call for cooling before allowing the contactor to energize.

Model Identification

● VE **S** **A** **● AC** ● ● ● ● ● ●

Refrigerant
 A = R410A

System Type
 Air Conditioner

Nominal Cooling
 12 = 11,000 BTUH
 24 = 24,000 BTUH
 30 = 30,000 BTUH
 36 = 36,000 BTUH
 42 = 42,000 BTUH
 48/49 = 48,000 BTUH
 60 = 60,000 BTUH
 72 = 72,000 BTUH

2-Stage Compressor

Electric Heat – kW
 000 = No Heat 080 = 8 kW
 022 = 2.2 kW 090 = 9 kW
 036 = 3.6 kW 100 = 10 kW
 040 = 4 kW 150 = 15 kW
 050 = 5 kW

Power Supply
 A = 208/230V,1ø,60Hz
 C = 208.230V,3ø,60Hz
 D = 460V,3ø,60Hz

Special Option Code
 R = Electric Reheat
 U = Scroll Compressor
 K = Coastal Package
 X = Hot Gas Bypass
 O = Opposite side compressor
 E = Extreme Duty
 D = Desert Duty

Configuration
 N = ComPac® I A/C
 C = ComPac® II A/C

Cabinet Color
 100 = Beige
 200 = Gray
 300 = Brown
 400 = White
 500 = Stainless Steel (Exterior Only)
 SS-500 = Stainless Steel
 600 = Dark Bronze
 700 = Aluminum Stucco

A = Air Source Vertical Package
H = High Efficiency Vertical Package

A2 = Internal Disconnect

Certified Efficiency and Capacity Ratings at ANSI/AHRI Standard 390 - AVPA Air Conditioners



Model Number	AVPA12			AVPA24			AVPA30			AVPA36			AVPA42			AVPA48			AVPA60			AVPA72			
	ACA	ACC	ACD	ACA	ACC	ACD	ACA	ACC	ACD	ACA	ACC	ACD	ACA	ACC	ACD	ACA	ACC	ACD	ACA	ACC	ACD	ACA	ACC	ACD	
Cooling BTUH ¹	10,800			24,000			29,000			35,000			42,000			46,000			54,500			62,000		70,000	
EER ²	9.00			9.25			9.25			9.25			9.25			9.50			9.25			10.00		10.00	
Rated Air Flow (CFM ³)	400			840			1,000			1,100			1,575			1,725			1,850			1,925		1,925	

¹Cooling rated at 95°F (35°C) outdoor and 80°F DB/67° WB (26.5°C DB/19.5°C WB) return air. ²EER=Energy Efficiency Ratio ³CFM=Cubic Feet per Minute
 Ratings are with no outside air. Performance will be affected by altitude.
 Ratings are at 230 volts for 208/230 volt units ("A" & "C" models) and 460 volts for "D" models. Operation of units at a different voltage from that of the rating point will affect performance and air flow.

Sensible Total Heat Ratio @ 95°F (35°C) Outside Air Dry Bulb - AVPA Air Conditioners

Model Number	AVPA12			AVPA24			AVPA30			AVPA36			AVPA42			AVPA48			AVPA60			AVPA72			
	ACA	ACC	ACD	ACA	ACC	ACD	ACA	ACC	ACD	ACA	ACC	ACD	ACA	ACC	ACD	ACA	ACC	ACD	ACA	ACC	ACD	ACA	ACC	ACD	
Total Capacity	10,800			24,000			29,000			35,000			42,000			46,000			54,500			62,000		70,000	
Sensible Heat Ratio	0.74			0.75			0.75			0.69			0.76			0.76			0.73			0.71		0.67	
Sensible Capacity	8,000			18,000			21,740			24,155			31,900			34,940			39,800			43,815		46,800	
Rated Air Flow (CFM ¹)	400			840			1,000			1,100			1,575			1,725			1,850			1,925		1,925	

¹CFM=Cubic Feet per Minute. Sensible heat ratios based upon ANSI/AHRI std. 390 outdoor air conditions of 95°F (35°C) and 80°F DB/67° WB (26.5°C DB/19.5°C WB) return air.

Cooling Performance (BTUH) at Various Outdoor Temperatures - AVPA Air Conditioners

Model Number	Outdoor Temperature											
	75°F / 24°C	80°F / 26.5°C	85°F / 29°C	90°F / 32°C	95°F / 35°C	100°F / 38°C	105°F / 40.5°C	110°F / 43.3°C	115°F / 46°C	120°F / 48.9°C	125°F / 51.7°C	130°F / 54.4°C
AVPA12AC	12,525	12,095	11,660	11,230	10,800	10,365	9,935	9,500	9,285	8,640		
AVPA24AC	27,840	26,880	25,920	24,960	24,000	23,040	22,080	21,120	20,640	19,200	18,240	17,280
AVPA30AC	33,640	32,480	31,320	30,160	29,000	27,840	26,680	25,520	24,940	23,200	22,040	20,880
AVPA36AC	40,600	39,200	37,800	36,400	35,000	33,600	32,200	30,800	30,100	28,000	26,600	25,200
AVPA42AC	48,720	47,040	45,360	43,680	42,000	40,320	38,640	36,960	36,120	33,600	31,920	30,240
AVPA48AC	53,360	51,520	49,680	47,840	46,000	44,160	42,320	40,480	39,560	36,800	34,960	33,120
AVPA60AC	63,220	61,040	58,860	56,680	54,500	52,320	50,140	47,960	46,870	43,600	41,420	39,240
AVPA72ACA	71,920	69,440	66,960	64,480	62,000	59,520	57,040	54,560	53,320	49,600	47,120	44,640
AVPA72ACC, ACD	81,200	78,400	75,600	72,800	70,000	67,200	64,400	61,600	60,200	56,000	53,200	50,400

Based upon ANSI/AHRI std. 390 return air conditions of 80°F DB/67° WB (26.5°C DB/19.5°C WB) at various outdoor temperatures.
 Note: Operation of units above 120°F (48.9°C) requires the Desert Duty package.

Electrical Characteristics - Compressor, Fan & Blower Motors - AVPA Air Conditioner

BASIC MODEL	COMPRESSOR				OUTDOOR FAN & INDOOR BLOWER MOTORS			OUTDOOR FAN MOTOR			INDOOR BLOWER MOTOR		
	TYPE	VOLTS / HZ / PH	RLA ¹	LRA ²	VOLTS / HZ / PH			RPM ³	FLA ⁴	HP ⁵	RPM ³	FLA ⁴	HP ⁵
AVPA12ACA	ROTARY	208/230-60-1	4.7	25.0	208/230-60-1			1630	0.65	1/6	1650	0.85	1/5
AVPA24ACA	SCROLL	208/230-60-1	10.6	54.0	208/230-60-1			1075	1.5	1/5	1075	1.5	1/5
AVPA30ACA		208/230-60-1	13.1	74.0	208/230-60-1			1075	1.8	1/4	1075	2.5	1/4
AVPA36ACA		208/230-60-1	14.7	84.0	208/230-60-1			1075	1.8	1/4	1075	2.5	1/4
AVPA42ACA		208/230-60-1	15.7	84.0	208/230-60-1			825	2.8	1/3	1075	3.1	1/2
AVPA48ACA		208/230-60-1	18.6	102.0	208/230-60-1			825	2.8	1/3	1075	3.1	1/2
AVPA60ACA		208/230-60-1	23.0	130.0	208/230-60-1			825	2.8	1/3	1075	5.2	3/4
AVPA24ACC		208/230-60-1	12.8	64.0	208/230-60-1			1075	1.5	1/5	1075	1.5	1/5
AVPA30ACC		208/230-60-1	14.1	77.0	208/230-60-1			1075	1.8	1/4	1075	2.5	1/4
AVPA36ACC		208/230-60-1	17.9	112.0	208/230-60-1			1075	1.8	1/4	1075	2.5	1/4
AVPA42ACC		208/230-60-1	19.8	109.0	208/230-60-1			825	2.8	1/3	1075	3.1	1/2
AVPA48ACC		208/230-60-1	21.8	117.0	208/230-60-1			825	2.8	1/3	1075	3.1	1/2
AVPA60ACC		208/230-60-1	26.2	134.0	208/230-60-1			825	2.8	1/3	1075	5.2	3/4
AVPA72ACA	208/230-60-1	30.1	158.0	208/230-60-1			825	2.9	1/2	1075	5.2	3/4	
AVPA24ACD	SCROLL	208/230-60-3	8.3	61.0	208/230-60-1			1075	1.5	1/5	1075	1.5	1/5
AVPA30ACD		208/230-60-3	9.0	71.0	208/230-60-1			1075	1.8	1/4	1075	2.5	1/4
AVPA36ACD		208/230-60-3	13.2	88.0	208/230-60-1			1075	1.8	1/4	1075	2.5	1/4
AVPA42ACD		208/230-60-3	13.6	83.1	208/230-60-1			825	2.8	1/3	1075	3.1	1/2
AVPA48ACD		208/230-60-3	13.7	83.1	208/230-60-1			825	2.8	1/3	1075	3.1	1/2
AVPA60ACD		208/230-60-3	15.6	111.0	208/230-60-1			825	2.8	1/3	1075	5.2	3/4
AVPA72ACC		208/230-60-3	22.4	149.0	208/230-60-1			825	2.9	1/2	1075	5.2	3/4
AVPA24ACD		460-60-3	5.1	28.0	208/230-60-1			1075	1.5	1/5	1075	1.5	1/5
AVPA30ACD		460-60-3	5.6	38.0	208/230-60-1			1075	1.8	1/4	1075	2.5	1/4
AVPA36ACD		460-60-3	6.0	44.0	208/230-60-1			1075	1.8	1/4	1075	2.5	1/4
AVPA42ACD		460-60-3	6.1	41.0	208/230-60-1			825	2.8	1/3	1075	3.1	1/2
AVPA48ACD		460-60-3	6.2	41.0	208/230-60-1			825	2.8	1/3	1075	3.1	1/2
AVPA60ACD	460-60-3	7.7	52.0	208/230-60-1			825	2.8	1/3	1075	5.2	3/4	
AVPA72ACD	460-60-3	10.6	75.0	208/230-60-1			825	2.9	1/2	1075	5.2	3/4	

¹RLA = Rated Load Amps ²LRA = Locked Rotor Amps ³RPM = Revolutions per Minute ⁴FLA = Full Load Amps ⁵HP = Horsepower
The 460 volt (ACD) units will have a step down transformer for the 230 volt motors.

Summary Electrical Ratings (Wire and Circuit Breaker Sizing) - AVPA Air Conditioners with Ventilation Configurations: Manual Damper, up to 15% Outside Air ("N") Economizer, Outside Air with Pressure Relief ("C")

ELECTRIC HEAT		000 = None		022 = 2.2 kw		036 = 3.6 kw		040 = 4 kw		050 = 5 kw		060 = 6 kw		080 = 8 kw		090 = 9 kw		100 = 10 kw		120 = 12 kw		150 = 15 kw		
BASIC MODEL	VOLTAGE PHASE / HZ	SPPE ³		SPPE ³		SPPE ³		SPPE ³		SPPE ³		SPPE ³		SPPE ³		SPPE ³		SPPE ³		SPPE ³		SPPE ³		
		MCA ¹	MFS ²	MCA ¹	MFS ²	MCA ¹	MFS ²	MCA ¹	MFS ²	MCA ¹	MFS ²	MCA ¹	MFS ²	MCA ¹	MFS ²	MCA ¹	MFS ²	MCA ¹	MFS ²	MCA ¹	MFS ²	MCA ¹	MFS ²	
AVPA12ACA	208/230-1-60	7.4	15	12.4	15	19.7	20																	
AVPA24ACA	208/230-1-60	19.0	30					22.4	30	27.5	30	32.8	35	43.1	45				53.6	60				
AVPA30ACA	208/230-1-60	21.9	35					23.4	35	28.5	35	33.8	35	44.1	45				54.6	60	65.0	70	80.6	90
AVPA36ACA	208/230-1-60	26.7	40					26.7	40	28.5	40	33.8	40	44.1	45				54.6	60	65.0	70	80.6	90
AVPA42ACA	208/230-1-60	30.7	50							30.7	50								55.2	60	65.6	70	81.2	90
AVPA48ACA	208/230-1-60	33.2	50							33.2	50								55.2	60	65.6	70	81.2	90
AVPA60ACA	208/230-1-60	40.8	60							40.8	60								57.3	60	67.7	70	83.3	90
AVPA72ACA	208/230-1-60	45.6	60							45.6	60								57.3	60	67.7	70	83.3	90
AVPA24ACC	208/230-3-60	13.4	20									19.5	20			28.6	30				37.6	40		
AVPA30ACC	208/230-3-60	15.6	20									20.5	25			29.6	30				38.6	40	47.6	50
AVPA36ACC	208/230-3-60	20.8	30									20.8	30			29.6	30				38.6	40	47.6	50
AVPA42ACC	208/230-3-60	22.9	35									22.9	35			30.2	35				39.1	40	48.1	50
AVPA48ACC	208/230-3-60	23.0	35									23.0	35			30.2	35				39.1	40	48.1	50
AVPA60ACC	208/230-3-60	27.5	40									27.5	40			32.3	40				41.3	45	50.2	60
AVPA72ACC	208/230-3-60	36.1	50									36.1	50			36.1	50				41.3	50	50.2	60
AVPA24ACD	460-3-60	7.9	15									9.8	15			14.3	15				18.8	20	23.3	25
AVPA30ACD	460-3-60	9.2	15									10.3	15			14.8	15				19.3	20	23.8	25
AVPA36ACD	460-3-60	9.7	15									10.3	15			14.8	15				19.3	20	23.8	25
AVPA42ACD	460-3-60	10.6	15									10.9	15			15.1	20				19.6	20	24.1	25
AVPA48ACD	460-3-60	10.7	15									10.9	15			15.1	20				19.6	20	24.1	25
AVPA60ACD	460-3-60	13.6	20									13.6	20			16.1	20				20.6	25	25.1	30
AVPA72ACD	460-3-60	17.3	25									17.3	25			17.3	25				20.6	25	25.1	30

¹MCA = Minimum Circuit Ampacity (Wiring Size Amps) ²MFS = Maximum Fuse or HACR Breaker Size ³SPPE = Single Point Power Entry
MCA & MFS are calculated at 230 volts on the ACA & ACC models. The 460 volts ACD models are calculated at 460 volts. This chart should only be used as a guideline for estimating conductor size and overcurrent protection. For the requirements of specific units, always refer to the data label on the unit.

Summary Electrical Ratings (Wire and Circuit Breaker Sizing) - AVPA Air Conditioners with Electric Reheat ("R") and Ventilation Configurations: Manual Damper, up to 15% Outside Air ("N") Economizer, Outside Air with Pressure Relief ("C")

ELECTRIC HEAT		022 = 2.2 kw		040 = 4 kw		050 = 5 kw		060 = 6 kw		080 = 8 kw		090 = 9 kw		100 = 10 kw		120 = 12 kw		150 = 15 kw	
BASIC MODEL	VOLTAGE PHASE / HZ	SPPE ³		SPPE ³		SPPE ³		SPPE ³		SPPE ³		SPPE ³		SPPE ³		SPPE ³		SPPE ³	
		MCA ¹	MFS ²	MCA ¹	MFS ²	MCA ¹	MFS ²	MCA ¹	MFS ²	MCA ¹	MFS ²	MCA ¹	MFS ²	MCA ¹	MFS ²	MCA ¹	MFS ²	MCA ¹	MFS ²
AVPA12ACA	208/230-1-60	18.9	20																
AVPA24ACA	208/230-1-60					45.0	45												
AVPA30ACA	208/230-1-60							53.2	60										
AVPA36ACA	208/230-1-60							58.0	60										
AVPA42ACA	208/230-1-60												82.8	90					
AVPA48ACA	208/230-1-60												85.3	90					
AVPA60ACA	208/230-1-60															103.3	110		
AVPA72ACA	208/230-1-60															108.1	110		
AVPA24ACC	208/230-3-60							31.4	35										
AVPA30ACC	208/230-3-60							33.6	35										
AVPA36ACC	208/230-3-60							38.8	40										
AVPA42ACC	208/230-3-60											50.0	50						
AVPA48ACC	208/230-3-60											50.1	60						
AVPA60ACC	208/230-3-60															63.6	70		
AVPA72ACC	208/230-3-60																	81.2	90
AVPA24ACD	460-3-60							16.9	20										
AVPA30ACD	460-3-60							18.2	20										
AVPA36ACD	460-3-60							18.7	20										
AVPA42ACD	460-3-60											24.1	25						
AVPA48ACD	460-3-60											24.2	25						
AVPA60ACD	460-3-60															31.6	35		
AVPA72ACD	460-3-60																	39.8	40

¹MCA = Minimum Circuit Ampacity (Wiring Size Amps) ²MFS = Maximum Fuse or HACR Breaker Size ³SPPE = Single Point Power Entry
MCA & MFS are calculated at 230 volts on the ACA & ACC models. The 460 volts ACD models are calculated at 460 volts. This chart should only be used as a guideline for estimating conductor size and overcurrent protection. For the requirements of specific units, always refer to the data label on the unit.

Unit Load Amps - AVPA Air Conditioners with Ventilation Configurations: Manual Damper, up to 15% Outside Air ("N") Economizer, Outside Air with Pressure Relief ("C")

BASIC MODEL NUMBER	VOLTAGE PHASE / HZ	CURRENT AMPS		LOAD OF RESISTIVE HEATING - ELEMENTS ONLY (AMPS)										TOTAL MAXIMUM HEATING AMPS													
				(1) ALL HEATING ELEMENTS ARE ON A SEPARATE CIRCUIT										INCLUDES AMPS FROM MOTOR(S) THAT ARE LOCATED ON AN ELECTRICAL CIRCUIT THAT DOES NOT HAVE HEATERS													
				AC ¹		IBM ²		2.2 kW	3.6 kW	04 kW	05 kW	06 kW	08 kW	09 kW	10 kW	12 kW	15 kW	2.2 kW	3.6 kW	04 kW	05 kW	06 kW	08 kW	09 kW	10 kW	12 kW	15 kW
AVPA12ACA	208/230-1-60	6.1	0.85	9.2	15.0				20.8							10.1	15.0										
AVPA24ACA	208/230-1-60	15.8	1.5			16.7	20.8	25.0	33.3		41.7							18.2	22.3	26.5	34.8		43.2				
AVPA30ACA	208/230-1-60	18.4	2.5			16.7	20.8	25.0	33.3		41.7	50.0	62.5				19.2	23.3	27.5	35.8		44.2	52.5	65.0			
AVPA36ACA	208/230-1-60	22.2	2.5			16.7	20.8	25.0	33.3		41.7	50.0	62.5				19.2	23.3	27.5	35.8		44.2	52.5	65.0			
AVPA42ACA	208/230-1-60	25.7	3.1				20.8				41.7	50.0	62.5					23.9				44.8	53.1	65.6			
AVPA48ACA	208/230-1-60	27.7	3.1				20.8				41.7	50.0	62.5					23.9				44.8	53.1	65.6			
AVPA60ACA	208/230-1-60	34.2	5.2				20.8				41.7	50.0	62.5					26.0				46.9	55.2	67.7			
AVPA72ACA	208/230-1-60	38.2	5.2				20.8				41.7	50.0	62.5					26.0				46.9	55.2	67.7			
AVPA24ACC	208/230-3-60	11.2	1.5					14.4		21.7		28.9	36.1						15.9		23.2		30.4	37.6			
AVPA30ACC	208/230-3-60	13.3	2.5					14.4		21.7		28.9	36.1						16.9		24.2		31.4	38.6			
AVPA36ACC	208/230-3-60	17.5	2.5					14.4		21.7		28.9	36.1						16.9		24.2		31.4	38.6			
AVPA42ACC	208/230-3-60	19.5	3.1					14.4		21.7		28.9	36.1						17.5		24.8		32.0	39.2			
AVPA48ACC	208/230-3-60	19.6	3.1					14.4		21.7		28.9	36.1						17.5		24.8		32.0	39.2			
AVPA60ACC	208/230-3-60	23.6	5.2					14.4		21.7		28.9	36.1						19.6		26.9		34.1	41.3			
AVPA72ACC	208/230-3-60	30.5	5.2					14.4		21.7		28.9	36.1						19.6		26.9		34.1	41.3			
AVPA24ACD	460-3-60	6.6	0.8					7.2		10.8		14.4	18.0						8.0		11.6		15.2	18.8			
AVPA30ACD	460-3-60	7.8	1.3					7.2		10.8		14.4	18.0						8.5		12.1		15.7	19.3			
AVPA36ACD	460-3-60	8.2	1.3					7.2		10.8		14.4	18.0						8.5		12.1		15.7	19.3			
AVPA42ACD	460-3-60	9.1	1.6					7.2		10.8		14.4	18.0						8.8		12.4		16.0	19.6			
AVPA48ACD	460-3-60	9.2	1.6					7.2		10.8		14.4	18.0						8.8		12.4		16.0	19.6			
AVPA60ACD	460-3-60	11.7	2.6					7.2		10.8		14.4	18.0						9.8		13.4		17.0	20.6			
AVPA72ACD	460-3-60	14.7	2.6					7.2		10.8		14.4	18.0						9.8		13.4		17.0	20.6			

¹AC = Air Conditioner Unit Amps ²IBM = Indoor Blower Motor
Heating kW is rated at 240 volts on the ACA & ACC models. Derate heater output by 25% for operation at 208 volts. Heating kW is rated at 480 volts on the ACD models. Total heating and cooling amps includes all motors. Three phase models contain single phase motor loads. Loads are not equally balanced on each phase and values shown are maximum phase loads.

HVEA High Efficiency Air Conditioners

Certified Efficiency and Capacity Ratings at ANSI/AHRI Standard 390 for HVEA Air Conditioners with Single Stage Compressor



Model Number	HVEA24			HVEA30			HVEA36			HVEA42			HVEA49			HVEA60		
	ACA	ACC	ACD	ACA	ACC	ACD	ACA	ACC	ACD	ACA	ACC	ACD	ACA	ACC	ACD	ACA	ACC	ACD
Cooling BTUH ¹	23,600			29,000			35,600			40,000			49,000			58,000		
EER ²	10.75			11.75			11.25			10.50			11.50			10.50		
Rated Air Flow (CFM ³)	800			1,000			1,300			1,400			1,750			1,900		

¹Cooling rated at 95°F (35°C) outdoor and 80°F DB/67° WB (26.5°C DB/19.5°C WB) return air ²EER=Energy Efficiency Ratio ³CFM=Cubic Feet per Minute
Ratings are with no outside air. Performance will be affected by altitude.
Ratings are at 230 volts for 208/230 volt units ("A" & "C" models) and 460 volts for "D" models. Operation of units at a different voltage from that of the rating point will affect performance and air flow.

Sensible Total Heat Ratio @ 95°F (35°C) Outside Air Dry Bulb - HVEA Air Conditioners with Single Stage Compressor

Model Number	HVEA24			HVEA30			HVEA36			HVEA42			HVEA49			HVEA60		
	ACA	ACC	ACD	ACA	ACC	ACD	ACA	ACC	ACD	ACA	ACC	ACD	ACA	ACC	ACD	ACA	ACC	ACD
Total Capacity	23,600			29,000			35,600			40,000			49,000			58,000		
Sensible Heat Ratio	0.74			0.76			0.76			0.73			0.74			0.73		
Sensible Capacity	17,435			22,020			26,945			29,270			36,175			42,505		
Rated Air Flow (CFM ¹)	800			1,000			1,300			1,400			1,750			1,900		

¹CFM=Cubic Feet per Minute
Sensible heat ratios based upon ANSI/AHRI std. 390 outdoor air conditions of 95°F (35°C) and 80°F DB/67° WB (26.5°C DB/19.5°C WB) return air.

Cooling Performance (BTUH) at Various Outdoor Temperatures for HVEA Air Conditioners with Single Stage Compressor

Model Number	Outdoor Temperature											
	75°F / 24°C	80°F / 26.5°C	85°F / 29°C	90°F / 32°C	95°F / 35°C	100°F / 38°C	105°F / 40.5°C	110°F / 43.3°C	115°F / 46.1°C	120°F / 48.9°C	125°F / 51.7°C	130°F / 54.4°C
HVEA24AC	27,375	26,430	25,490	24,545	23,600	22,655	21,710	20,770	20,295	19,870	19,445	19,020
HVEA30AC	33,640	32,480	31,320	30,160	29,000	27,840	26,680	25,520	24,940	24,420	23,895	23,375
HVEA36AC	41,295	39,870	38,450	37,025	35,600	34,175	32,750	31,320	30,615	29,975	29,335	28,695
HVEA42AC	46,400	44,800	43,200	41,600	40,000	38,400	36,800	35,200	34,400	33,680	32,960	32,240
HVEA49AC	56,840	54,880	52,920	50,960	49,000	47,040	45,080	43,120	42,140	41,260	40,375	39,495
HVEA60AC	67,280	64,960	62,640	60,320	58,000	55,680	53,360	51,040	49,880	48,835	47,790	46,745

Based upon ANSI/AHRI std. 390 return air conditions of 80°F DB/67° WB (26.5°C DB/19.5°C WB) at various outdoor temperatures.

Electrical Characteristics - Compressor, Fan & Blower Motors - HVEA Air Conditioner with Single Stage Compressor

BASIC MODEL	COMPRESSOR				OUTDOOR FAN MOTOR				INDOOR FAN MOTOR (ECM)			
	Type	VOLTS-HZ-PH	RLA ¹	LRA ²	VOLTS-HZ-PH	RPM ³	FLA ⁴	HP ⁵	VOLTS-HZ-PH	RPM ³	FLA ⁴	HP ⁵
HVEA24ACA	SCROLL	208/230-60-1	12.8	58.3	208/230-60-1	1075	1.8	1/4	208/230-60-1	1500	2.8	1/3
HVEA30ACA		208/230-60-1	12.8	64.0	208/230-60-1	825	2.8	1/3	208/230-60-1	1500	2.8	1/2
HVEA36ACA		208/230-60-1	16.6	79.0	208/230-60-1	825	2.8	1/3	208/230-60-1	1500	2.8	1/2
HVEA42ACA		208/230-60-1	19.8	109.0	208/230-60-1	825	2.8	1/3	208/230-60-1	1500	2.8	1/2
HVEA49ACA		208/230-60-1	21.8	117.0	208/230-60-1	825	2.8	1/2	208/230-60-1	1500	4.3	3/4
HVEA60ACA		208/230-60-1	26.4	134.0	208/230-60-1	825	2.8	1/2	208/230-60-1	1500	4.3	3/4
HVEA24ACC	SCROLL	208/230-60-3	7.7	55.4	208/230-60-1	1075	1.8	1/4	208/230-60-1	1500	2.8	1/3
HVEA30ACC		208/230-60-3	8.3	61.0	208/230-60-1	825	2.8	1/3	208/230-60-1	1500	2.8	1/2
HVEA36ACC		208/230-60-3	10.4	88.0	208/230-60-1	825	2.8	1/3	208/230-60-1	1500	2.8	1/2
HVEA42ACC		208/230-60-3	13.6	83.1	208/230-60-1	825	2.8	1/3	208/230-60-1	1500	2.8	1/2
HVEA49ACC		208/230-60-3	13.7	83.1	208/230-60-1	825	2.8	1/2	208/230-60-1	1500	4.3	3/4
HVEA60ACC		208/230-60-3	15.9	111.0	208/230-60-1	825	2.8	1/2	208/230-60-1	1500	4.3	3/4
HVEA24ACD	SCROLL	460-60-3	4.0	28.0	208/230-60-1	1075	1.8	1/4	208/230-60-1	1500	2.8	1/3
HVEA30ACD		460-60-3	5.1	28.0	208/230-60-1	825	2.8	1/3	208/230-60-1	1500	2.8	1/2
HVEA36ACD		460-60-3	5.8	38.0	208/230-60-1	825	2.8	1/3	208/230-60-1	1500	2.8	1/2
HVEA42ACD		460-60-3	6.1	41.0	208/230-60-1	825	2.8	1/3	208/230-60-1	1500	2.8	1/2
HVEA49ACD		460-60-3	6.2	41.0	208/230-60-1	825	2.8	1/2	208/230-60-1	1500	4.3	3/4
HVEA60ACD		460-60-3	7.7	52.0	208/230-60-1	825	2.8	1/2	208/230-60-1	1500	4.3	3/4

¹RLA = Rated Load Amps ²LRA = Locked Rotor Amps ³RPM = Revolutions per Minute ⁴FLA = Full Load Amps ⁵HP = Horsepower
The 460 volt units will have a step down transformer for the 230 volt motors.

Summary Electrical Ratings (Wire and Circuit Breaker Sizing) - HVEA Air Conditioners with Single stage Compressors & Ventilation Configurations: Manual Damper, up to 15% Outside Air ("N") Economizer, Outside Air with Pressure Relief ("C")

ELECTRIC HEAT		000 = None		040 = 4 kw		050 = 5 kw		060 = 6 kw		080 = 8 kw		090 = 9 kw		100 = 10 kw		120 = 12 kw		150 = 15 kw	
BASIC MODEL	VOLTAGE PHASE / HZ	SPPE ³		SPPE ³		SPPE ³		SPPE ³		SPPE ³		SPPE ³		SPPE ³		SPPE ³		SPPE ³	
		MCA ¹	MFS ²	MCA ¹	MFS ²	MCA ¹	MFS ²	MCA ¹	MFS ²	MCA ¹	MFS ²	MCA ¹	MFS ²	MCA ¹	MFS ²	MCA ¹	MFS ²	MCA ¹	MFS ²
HVEA24ACA	208/230-1-60	20.6	30	23.1	30	28.8	30	34.1	35	44.4	45			54.9	60				
HVEA30ACA	208/230-1-60	21.6	30	23.1	30	28.8	30	34.1	35	44.4	45			54.9	60	65.3	70	80.9	90
HVEA36ACA	208/230-1-60	26.4	40	26.4	40	28.8	40	34.1	35	44.4	45			54.9	60	65.3	70	80.9	90
HVEA42ACA	208/230-1-60	30.4	50			30.4	50							54.9	60	65.3	70	80.9	90
HVEA49ACA	208/230-1-60	34.4	50			34.4	50							56.4	60	66.8	70	82.4	90
HVEA60ACA	208/230-1-60	40.1	60			40.1	60							56.4	60	66.8	70	82.4	90
HVEA24ACC	208/230-3-60	14.2	20					20.8	25			29.9	30			38.9	40		
HVEA30ACC	208/230-3-60	16.0	20					20.8	25			29.9	30			38.9	40	47.9	50
HVEA36ACC	208/230-3-60	18.6	25					20.8	25			29.9	30			38.9	40	47.9	50
HVEA42ACC	208/230-3-60	22.6	35					22.6	35			29.9	35			38.9	40	47.9	50
HVEA49ACC	208/230-3-60	24.2	35					24.2	35			31.4	35			40.4	50	49.4	50
HVEA60ACC	208/230-3-60	27.0	40					27.0	40			31.4	40			40.4	50	49.4	50
HVEA24ACD	460-3-60	7.3	15					10.4	15			14.9	15			19.4	20	23.9	25
HVEA30ACD	460-3-60	9.2	15					10.4	15			14.9	15			19.4	20	23.9	25
HVEA36ACD	460-3-60	10.1	15					10.4	15			14.9	15			19.4	20	23.9	25
HVEA42ACD	460-3-60	10.4	15					10.4	15			14.9	15			19.4	20	23.9	25
HVEA49ACD	460-3-60	11.3	15					11.3	15			15.7	20			20.2	25	24.7	25
HVEA60ACD	460-3-60	13.2	20					13.2	20			15.7	20			20.2	25	24.7	25

¹MCA = Minimum Circuit Ampacity (Wiring Size Amps) ²MFS = Maximum Fuse or HACR Breaker Size ³SPPE = Single Point Power Entry
MCA & MFS are calculated at 230 volts on the ACA & ACC models. The 460 volts ACD models are calculated at 460 volts. This chart should only be used as a guideline for estimating conductor size and overcurrent protection. For the requirements of specific units, always refer to the data label on the unit.

Summary Electrical Ratings (Wire and Circuit Breaker Sizing) - HVEA Air Conditioners with Electric Reheat ("R") with Single stage Compressors and Ventilation Configurations: Manual Damper, up to 15% Outside Air ("N") Economizer, Outside Air with Pressure Relief ("C")

ELECTRIC HEAT		000 = None		040 = 4 kw		050 = 5 kw		060 = 6 kw		080 = 8 kw		090 = 9 kw		100 = 10 kw		120 = 12 kw		150 = 15 kw	
BASIC MODEL	VOLTAGE PHASE / HZ	SPPE ³		SPPE ³		SPPE ³		SPPE ³		SPPE ³		SPPE ³		SPPE ³		SPPE ³		SPPE ³	
		MCA ¹	MFS ²	MCA ¹	MFS ²	MCA ¹	MFS ²	MCA ¹	MFS ²	MCA ¹	MFS ²	MCA ¹	MFS ²	MCA ¹	MFS ²	MCA ¹	MFS ²	MCA ¹	MFS ²
HVEA24ACA	208/230-1-60	20.6	30	41.5	45	46.6	50	51.9	60					72.7	80				
HVEA30ACA	208/230-1-60	21.6	30	42.5	45	47.6	50	52.9	60					73.7	80	84.1	90	99.7	100
HVEA36ACA	208/230-1-60	26.4	40	47.3	50	52.4	60	57.7	60					78.5	80	88.9	90	104.5	110
HVEA42ACA	208/230-1-60	30.4	50			56.4	60							82.5	90	92.9	100	108.5	110
HVEA49ACA	208/230-1-60	34.4	50			60.4	70							86.5	90	96.9	100	112.5	120
HVEA60ACA	208/230-1-60	40.1	60			66.1	70							92.2	100	102.6	110	118.2	120
HVEA24ACC	208/230-3-60	14.2	20					32.2	35			41.3	45			50.3	60	59.3	60
HVEA30ACC	208/230-3-60	16.0	20					34.0	35			43.1	45			52.1	60	61.1	70
HVEA36ACC	208/230-3-60	18.6	25					36.6	40			45.7	50			54.7	60	63.7	70
HVEA42ACC	208/230-3-60	22.6	35					40.6	45			49.7	50			58.7	60	67.7	70
HVEA49ACC	208/230-3-60	24.2	35					42.2	45			51.3	60			60.3	70	69.3	70
HVEA60ACC	208/230-3-60	27.0	40					45.0	45			54.1	60			63.1	70	72.1	80
HVEA24ACD	460-3-60	7.3	15					16.3	20			20.8	25			25.3	30	29.8	30
HVEA30ACD	460-3-60	9.2	15					18.2	20			22.7	25			27.2	30	31.7	35
HVEA36ACD	460-3-60	10.1	15					19.1	20			23.6	25			28.1	30	32.6	35
HVEA42ACD	460-3-60	10.4	15					19.4	20			23.9	25			28.4	30	32.9	35
HVEA49ACD	460-3-60	11.3	15					20.3	25			24.8	25			29.3	30	33.8	35
HVEA60ACD	460-3-60	13.2	20					22.2	25			26.7	30			31.2	35	35.7	40

¹MCA = Minimum Circuit Ampacity (Wiring Size Amps) ²MFS = Maximum Fuse or HACR Breaker Size ³SPPE = Single Point Power Entry
MCA & MFS are calculated at 230 volts on the ACA & ACC models. The 460 volts ACD models are calculated at 460 volts. This chart should only be used as a guideline for estimating conductor size and overcurrent protection. For the requirements of specific units, always refer to the data label on the unit.

Unit Load Amps - HVEA Air Conditioners with with Single stage Compressors and Ventilation Configurations: Manual Damper, up to 15% Outside Air ("N") Economizer, Outside Air with Pressure Relief ("C")

BASIC MODEL NUMBER	VOLTAGE PHASE / HZ	CURRENT AMPS		LOAD OF RESISTIVE HEATING - ELEMENTS ONLY (AMPS) <small>(1) ALL HEATING ELEMENTS ARE ON A SEPARATE CIRCUIT (2) SHADED VALUES (12 & 15 kW) UTILIZE TWO CIRCUITS</small>										TOTAL MAXIMUM HEATING AMPS <small>INCLUDES AMPS FROM MOTOR(S) THAT ARE LOCATED ON AN ELECTRICAL CIRCUIT THAT DOES NOT HAVE HEATERS</small>								
		AC ¹	IBM ²	04 kW	05 kW	06 kW	08 kW	09 kW	10 kW	12 kW	15 kW	04 Kw	05 Kw	06 Kw	08 Kw	09 Kw	10 Kw	12 Kw	15 Kw			
HVEA24ACA	208/230-1-60	17.4	2.8	16.7	20.8	25.0	33.3		41.7						19.5	23.6	27.8	36.1		44.5		
HVEA30ACA	208/230-1-60	18.4	2.8	16.7	20.8	25.0	33.3		41.7	50.0	62.5	19.5	23.6	27.8	36.1		44.5	52.8	65.3			
HVEA36ACA	208/230-1-60	22.2	2.8	16.7	20.8	25.0	33.3		41.7	50.0	62.5	19.5	23.6	27.8	36.1		44.5	52.8	65.3			
HVEA42ACA	208/230-1-60	25.4	2.8		20.8				41.7	50.0	62.5		23.6				44.5	52.8	65.3			
HVEA49ACA	208/230-1-60	28.9	4.3		20.8				41.7	50.0	62.5		25.1				46.0	54.3	66.8			
HVEA60ACA	208/230-1-60	33.5	4.3		20.8				41.7	50.0	62.5		25.1				46.0	54.3	66.8			
HVEA24ACC	208/230-3-60	12.3	2.8			14.4		21.7		28.9	36.1			17.2		24.5		31.7	38.9			
HVEA30ACC	208/230-3-60	13.9	2.8			14.4		21.7		28.9	36.1			17.2		24.5		31.7	38.9			
HVEA36ACC	208/230-3-60	16.0	2.8			14.4		21.7		28.9	36.1			17.2		24.5		31.7	38.9			
HVEA42ACC	208/230-3-60	19.2	2.8			14.4		21.7		28.9	36.1			17.2		24.5		31.7	38.9			
HVEA49ACC	208/230-3-60	20.8	4.3			14.4		21.7		28.9	36.1			18.7		26.0		33.2	40.4			
HVEA60ACC	208/230-3-60	23.0	4.3			14.4		21.7		28.9	36.1			18.7		26.0		33.2	40.4			
HVEA24ACD	460-3-60	6.3	1.4			7.2		10.8		14.4	18.0			8.6		12.2		15.8	19.4			
HVEA30ACD	460-3-60	7.9	1.4			7.2		10.8		14.4	18.0			8.6		12.2		15.8	19.4			
HVEA36ACD	460-3-60	8.6	1.4			7.2		10.8		14.4	18.0			8.6		12.2		15.8	19.4			
HVEA42ACD	460-3-60	8.9	1.4			7.2		10.8		14.4	18.0			8.6		12.2		15.8	19.4			
HVEA49ACD	460-3-60	9.8	2.2			7.2		10.8		14.4	18.0			9.4		13.0		16.6	20.2			
HVEA60ACD	460-3-60	11.3	2.2			7.2		10.8		14.4	18.0			9.4		13.0		16.6	20.2			

¹AC = Air Conditioner Unit Amps ²IBM = Indoor Blower Motor
Heating kW is rated at 240 volts on the ACA & ACC models. Derate heater output by 25% for operation at 208 volts. Heating kW is rated at 480 volts on the ACD models.
Total heating and cooling amps includes all motors. Three phase models contain single phase motor loads. Loads are not equally balanced on each phase and values shown are maximum phase loads.

Certified Efficiency and Capacity Ratings at ANSI/AHRI Standard 390 for HVESA Air Conditioners with 2-Stage Compressors



Model Number	HVESA36			HVESA42			HVESA49			HVESA60		
	ACA	ACC	ACD	ACA	ACC	ACD	ACA	ACC	ACD	ACA	ACC	ACD
Cooling BTUH ¹ - 2nd Stage	35,000			39,000			47,000			56,000		
EER ² - 2nd Stage	11.00			10.50			11.75			10.50		
Integrated Part Load Value ³	16.0			14.1			16.0			14.8		
Rated Air Flow (CFM ⁴)	1,300			1,400			1,750			1,900		

¹Cooling rated at 95°F (35°C) outdoor and 80°F DB/67° WB (26.5°C DB/19.5°C WB) return air. ²EER=Energy Efficiency Ratio
³Integrated Part Load Value is an integrated efficiency measure from 1st and 2nd stage capacity modulation. ⁴CFM=Cubic Feet per Minute
Ratings are with no outside air. Performance will be affected by altitude.
Ratings are at 230 volts for 208/230 volt units ("A" & "C" models) and 460 volts for "D" models. Operation of units at a different voltage from that of the rating point will affect performance and air flow.

Sensible Total Heat Ratio @ 95°F (35°C) Outside Air Dry Bulb - HVESA Air Conditioners with 2-Stage Compressors

Model Number	HVESA36			HVESA42			HVESA49			HVESA60		
	ACA	ACC	ACD	ACA	ACC	ACD	ACA	ACC	ACD	ACA	ACC	ACD
Total Capacity	35,000			39,000			47,000			56,000		
Sensible Heat Ratio	0.70			0.71			0.79			0.77		
Sensible Capacity	24,445			27,590			36,920			43,235		
Rated Air Flow (CFM ¹)	1,300			1,400			1,750			1,900		

¹CFM=Cubic Feet per Minute
Sensible heat ratios based upon ANSI/AHRI std. 390 outdoor air conditions of 95°F (35°C) and 80°F DB/67° WB (26.5°C DB/19.5°C WB) return air.

Stage 2 Cooling Performance (BTUH) at Various Outdoor Temperatures

Model Number	Outdoor Temperature				
	75°F / 24°C	80°F / 26.5°C	85°F / 29°C	90°F / 32°C	95°F / 35°C
HVESA36AC	40,600	39,200	37,800	36,400	35,000
HVESA42AC	45,240	43,680	42,120	40,560	39,000
HVESA49AC	54,520	52,640	50,760	48,880	47,000
HVESA60AC	64,960	62,720	60,480	58,240	56,000

Based upon ANSI/AHRI std. 390 return air conditions of 80°F DB/67° WB (26.5°C DB/19.5°C WB) at various outdoor temperatures.

Stage 1 Cooling Performance (BTUH) at Various Outdoor Temperatures

Model Number	Outdoor Temperature				
	75°F / 24°C	80°F / 26.5°C	85°F / 29°C	90°F / 32°C	95°F / 35°C
HVESA36AC	30,856	29,792	28,728	27,664	26,600
HVESA42AC	34,336	33,152	31,968	30,784	29,600
HVESA49AC	44,080	42,560	41,040	39,520	38,000
HVESA60AC	51,040	49,280	47,520	45,760	44,000

Based upon ANSI/AHRI std. 390 return air conditions of 80°F DB/67° WB (26.5°C DB/19.5°C WB) at various outdoor temperatures.

Electrical Characteristics - Compressor, Fan & Blower Motors - HVESA Air Conditioner with 2-Stage Compressor

BASIC MODEL	Type	COMPRESSOR			OUTDOOR FAN MOTOR				INDOOR FAN MOTOR (ECM ⁶)			
		VOLTS-HZ-PH	RLA ¹	LRA ²	VOLTS-HZ-PH	RPM ³	FLA ⁴	HP ⁵	VOLTS-HZ-PH	RPM ³	FLA ⁴	HP ⁵
HVESA36ACA	SCROLL	208/230-60-1	16.6	82.0	208/230-60-1	825	2.8	1/3	208/230-60-1	1500	2.8	1/2
HVESA42ACA		208/230-60-1	16.6	96.0	208/230-60-1	825	2.8	1/3	208/230-60-1	1500	2.8	1/2
HVESA49ACA		208/230-60-1	21.1	96.0	208/230-60-1	825	2.8	1/2	208/230-60-1	1500	4.3	3/4
HVESA60ACA		208/230-60-1	25.6	118.0	208/230-60-1	825	2.8	1/2	208/230-60-1	1500	4.3	3/4
HVESA36ACC	SCROLL	208/230-60-3	11.1	58.0	208/230-60-1	825	2.8	1/3	208/230-60-1	1500	2.8	1/2
HVESA42ACC		208/230-60-3	13.4	88.0	208/230-60-1	825	2.8	1/3	208/230-60-1	1500	2.8	1/2
HVESA49ACC		208/230-60-3	13.4	88.0	208/230-60-1	825	2.8	1/2	208/230-60-1	1500	4.3	3/4
HVESA60ACC		208/230-60-3	17.6	123.0	208/230-60-1	825	2.8	1/2	208/230-60-1	1500	4.3	3/4
HVESA36ACD	SCROLL	460-60-3	4.5	29.0	208/230-60-1	825	2.8	1/3	208/230-60-1	1500	2.8	1/2
HVESA42ACD		460-60-3	6.1	44.0	208/230-60-1	825	2.8	1/3	208/230-60-1	1500	2.8	1/2
HVESA49ACD		460-60-3	6.4	41.0	208/230-60-1	825	2.8	1/2	208/230-60-1	1500	4.3	3/4
HVESA60ACD		460-60-3	9.0	62.0	208/230-60-1	825	2.8	1/2	208/230-60-1	1500	4.3	3/4

¹RLA = Rated Load Amps ²LRA = Locked Rotor Amps ³RPM = Revolutions per Minute ⁴FLA = Full Load Amps ⁵HP = Horsepower ⁶ECM = Electronically Commutated Motor
The 460 volt units have a step down transformer for the 230 volt motors.

Summary Electrical Ratings (Wire and Circuit Breaker Sizing) - HVESA Air Conditioners with Two Stage Compressor and Ventilation Configurations:

*Manual Damper, up to 15% Outside Air ("N")
Economizer, Outside Air with Pressure Relief ("C")*

ELECTRIC HEAT		000 = None		040 = 4 kw		050 = 5 kw		060 = 6 kw		080 = 8 kw		090 = 9 kw		100 = 10 kw		120 = 12 kw		150 = 15 kw	
BASIC MODEL	VOLTAGE PHASE / HZ	SPPE ³		SPPE ³		SPPE ³		SPPE ³		SPPE ³		SPPE ³		SPPE ³		SPPE ³		SPPE ³	
		MCA ¹	MFS ²	MCA ¹	MFS ²	MCA ¹	MFS ²	MCA ¹	MFS ²	MCA ¹	MFS ²	MCA ¹	MFS ²	MCA ¹	MFS ²	MCA ¹	MFS ²	MCA ¹	MFS ²
HVESA36ACA	208/230-1-60	24.6	35	24.6	35	28.8	35	34.1	35	44.4	45			54.9	60	65.3	70	80.9	90
HVESA42ACA	208/230-1-60	28.0	45			28.8	45							54.9	60	65.3	70	80.9	90
HVESA49ACA	208/230-1-60	33.5	50			33.5	50							56.4	60	66.8	70	82.4	90
HVESA60ACA	208/230-1-60	41.0	60			41.0	60							56.4	60	66.8	70	82.4	90
HVESA36ACC	208/230-3-60	20.1	30					20.8	25			29.9	30			38.9	40	47.9	50
HVESA42ACC	208/230-3-60	23.2	35					23.2	35			29.9	35			38.9	40	47.9	50
HVESA49ACC	208/230-3-60	24.6	35					24.6	35			31.4	35			40.4	50	49.4	50
HVESA60ACC	208/230-3-60	27.7	40					27.7	40			31.4	40			40.4	50	49.4	50
HVESA36ACD	460-3-60	9.9	15					10.4	15			14.9	15			19.4	20	23.9	25
HVESA42ACD	460-3-60	10.6	15					10.6	15			14.9	15			19.4	20	23.9	25
HVESA49ACD	460-3-60	11.6	15					11.6	15			15.7	20			20.2	25	24.7	25
HVESA60ACD	460-3-60	12.6	15					12.6	20			15.7	20			20.2	25	24.7	25

¹MCA = Minimum Circuit Ampacity (Wiring Size Amps) ²MFS = Maximum Fuse or HACR Breaker Size ³SPPE = Single Point Power Entry
MCA & MFS are calculated at 230 volts on the ACA & ACC models. The 460 volts ACD models are calculated at 460 volts. This chart should only be used as a guideline for estimating conductor size and overcurrent protection. For the requirements of specific units, always refer to the data label on the unit.

Summary Electrical Ratings (Wire and Circuit Breaker Sizing) - HVESA Air Conditioners with Two Stage Compressor, Electric Reheat ("R") and Ventilation Configurations: Manual Damper, up to 15% Outside Air ("N") Economizer, Outside Air with Pressure Relief ("C")

ELECTRIC HEAT		000 = None		040 = 4 kw		050 = 5 kw		060 = 6 kw		080 = 8 kw		090 = 9 kw		100 = 10 kw		120 = 12 kw		150 = 15 kw	
BASIC MODEL	VOLTAGE PHASE / HZ	SPPE ³		SPPE ³		SPPE ³		SPPE ³		SPPE ³		SPPE ³		SPPE ³		SPPE ³		SPPE ³	
		MCA ¹	MFS ²	MCA ¹	MFS ²	MCA ¹	MFS ²	MCA ¹	MFS ²	MCA ¹	MFS ²	MCA ¹	MFS ²	MCA ¹	MFS ²	MCA ¹	MFS ²	MCA ¹	MFS ²
HVESA36ACA	208/230-1-60	24.6	35	45.5	50	50.6	60	55.9	60					76.7	80	87.1	90	102.7	110
HVESA42ACA	208/230-1-60	28.0	45			54.0	60							80.1	90	90.5	100	106.1	110
HVESA49ACA	208/230-1-60	33.5	50			59.5	60							85.6	90	96.0	100	111.6	120
HVESA60ACA	208/230-1-60	41.0	60			67.0	70							93.1	100	103.5	110	119.1	120
HVESA36ACC	208/230-3-60	20.1	30					38.1	40			47.2	50			56.2	60	65.2	70
HVESA42ACC	208/230-3-60	23.2	35					41.2	45			50.3	60			59.3	60	68.3	70
HVESA49ACC	208/230-3-60	24.6	35					42.6	45			51.7	60			60.7	70	69.7	70
HVESA60ACC	208/230-3-60	27.7	40					45.7	50			54.8	60			63.8	70	72.8	80
HVESA36ACD	460-3-60	9.9	15					18.9	20			23.4	25			27.9	30	32.4	35
HVESA42ACD	460-3-60	10.6	15					19.6	20			24.1	25			28.6	30	33.1	35
HVESA49ACD	460-3-60	11.6	15					20.6	25			25.1	30			29.6	30	34.1	35
HVESA60ACD	460-3-60	12.6	15					21.6	25			26.1	30			30.6	35	35.1	40

¹MCA = Minimum Circuit Ampacity (Wiring Size Amps) ²MFS = Maximum Fuse or HACR Breaker Size ³SPPE = Single Point Power Entry
MCA & MFS are calculated at 230 volts on the ACA & ACC models. The 460 volts ACD models are calculated at 460 volts. This chart should only be used as a guideline for estimating conductor size and overcurrent protection. For the requirements of specific units, always refer to the data label on the unit.

Unit Load Amps - HVESA Air Conditioners with Two Stage Compressor and Ventilation Configurations: Manual Damper, up to 15% Outside Air ("N") Economizer, Outside Air with Pressure Relief ("C")

BASIC MODEL NUMBER	VOLTAGE PHASE / HZ	CURRENT AMPS		LOAD OF RESISTIVE HEATING - ELEMENTS ONLY (AMPS) (1) ALL HEATING ELEMENTS ARE ON A SEPARATE CIRCUIT (2) SHADED VALUES (12 & 15 kW) UTILIZE TWO CIRCUITS								TOTAL MAXIMUM HEATING AMPS INCLUDES AMPS FROM MOTOR(S) THAT ARE LOCATED ON AN ELECTRICAL CIRCUIT THAT DOES NOT HAVE HEATERS							
		AC ¹	IBM ²	04 kW	05 kW	06 kW	08 kW	09 kW	10 kW	12 kW	15 kW	04 Kw	05 Kw	06 Kw	08 Kw	09 Kw	10 Kw	12 Kw	15 Kw
HVESA36ACA	208/230-1-60	20.8	2.8	16.7	20.8	25.0	33.3		41.7	50.0	62.5	19.5	23.6	27.8	36.1		44.5	52.8	65.3
HVESA42ACA	208/230-1-60	23.5	2.8		20.8				41.7	50.0	62.5		23.6				44.5	52.8	65.3
HVESA49ACA	208/230-1-60	28.2	4.3		20.8				41.7	50.0	62.5		25.1				46.0	54.3	66.8
HVESA60ACA	208/230-1-60	34.2	4.3		20.8				41.7	50.0	62.5		25.1				46.0	54.3	66.8
HVESA36ACC	208/230-3-60	17.2	2.8			14.4		21.7		28.9	36.1			17.2		24.5		31.7	38.9
HVESA42ACC	208/230-3-60	19.7	2.8			14.4		21.7		28.9	36.1			17.2		24.5		31.7	38.9
HVESA49ACC	208/230-3-60	21.1	4.3			14.4		21.7		28.9	36.1			18.7		26.0		33.2	40.4
HVESA60ACC	208/230-3-60	23.6	4.3			14.4		21.7		28.9	36.1			18.7		26.0		33.2	40.4
HVESA36ACD	460-3-60	8.5	1.4			7.2		10.8		14.4	18.0			8.6		12.2		15.8	19.4
HVESA42ACD	460-3-60	9.0	1.4			7.2		10.8		14.4	18.0			8.6		12.2		15.8	19.4
HVESA49ACD	460-3-60	9.2	2.2			7.2		10.8		14.4	18.0			9.4		13.0		16.6	20.2
HVESA60ACD	460-3-60	10.0	2.2			7.2		10.8		14.4	18.0			9.4		13.0		16.6	20.2

¹AC = Air Conditioner Unit Amps ²IBM = Indoor Blower Motor
Heating kW is rated at 240 volts on the ACA & ACC models. Derate heater output by 25% for operation at 208 volts. Heating kW is rated at 480 volts on the ACD models.
Total heating and cooling amps includes all motors. Three phase models contain single phase motor loads. Loads are not equally balanced on each phase and values shown are maximum phase loads.

Dimensional Data - AVPA12 ComPac® I Air Conditioners

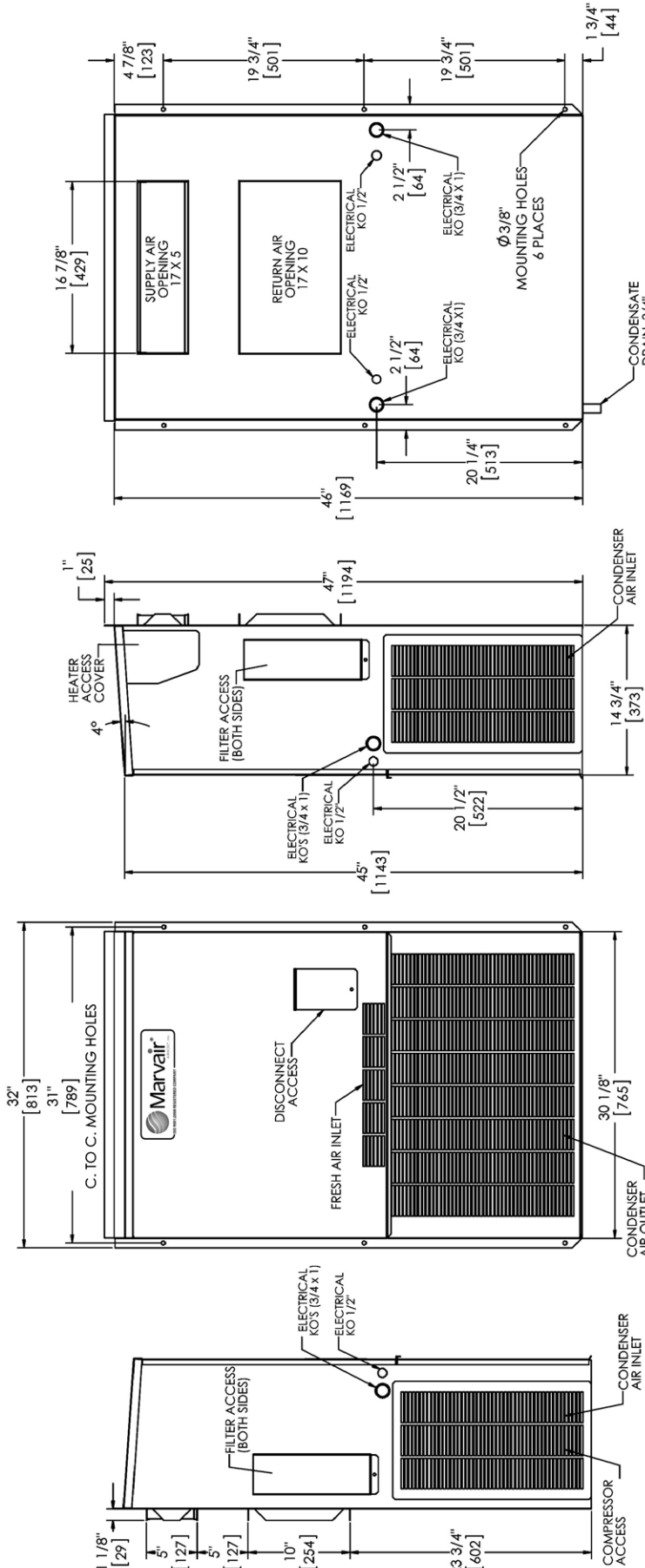

Shipping Weight (pounds/kilograms)

Model	LBS / KGS
AVPA12	185/84
COMPAC I	185/84

Filter Size

Filter Type	INCHES	MILLIMETERS	PART NUMBER	FILTERS PER UNIT	MERV RATING
AVPA12	10" x 20" x 2"	254 x 508 x 52	91974	1	7
RETURN AIR FILTER	10" x 20" x 2"	254 x 508 x 52	91974	1	7

Dimensional Data - AVPA12 ComPac® II Air Conditioners

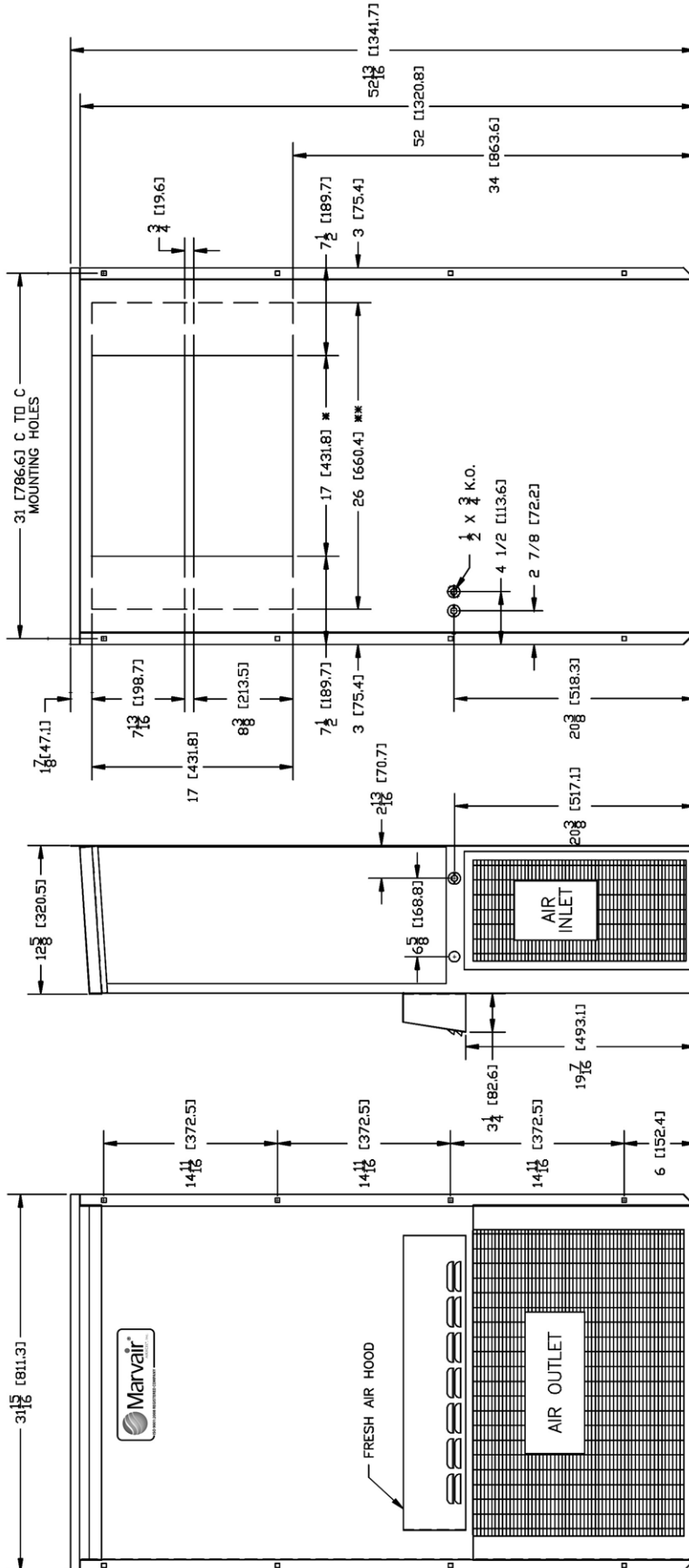

Shipping Weight (pounds/kilograms)

	LBS / KGS
AVPA12	194/88
COMPAC II	194/88

Filter Size

AVPA12	INCHES	MILLIMETERS	PART NUMBER	FILTERS PER UNIT	MERV RATING
RETURN AIR FILTER	6 1/4" x 22 1/4" x 2"	159 x 565 x 52	80.172	1	7

Dimensional Data - AVPA24 ComPac® I & II Air Conditioners

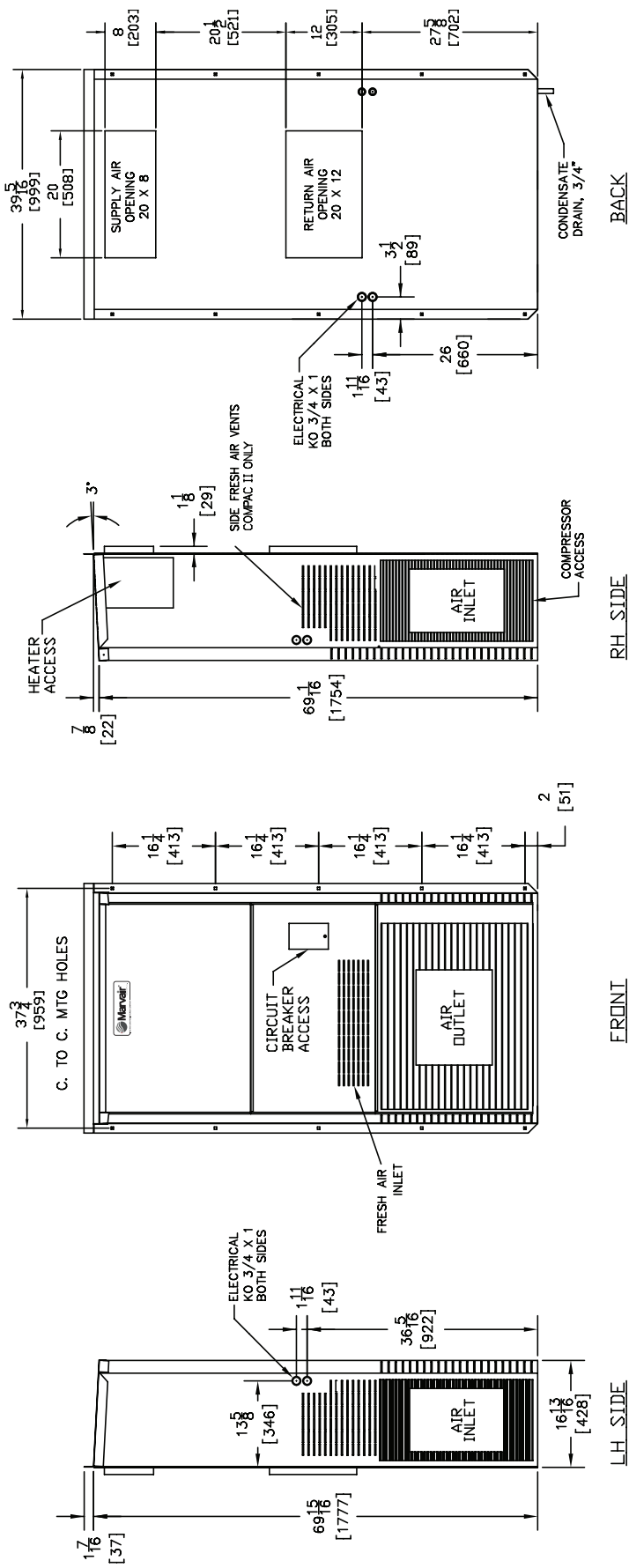

Shipping Weight (pounds/kilograms)

Model	LBS/KGS
AVPA24 COMPAC I	275/125
AVPA24 COMPAC II	286/130

Filter Size

Filter Type	INCHES	MILLIMETERS	PART NUMBER	FILTERS PER UNIT	MERV RATING
AVPA24 RETURN AIR FILTER	25" x 16" x 2"	635 x 406 x 51	80137	1	7

BOTTOM MOUNTING BRACKET

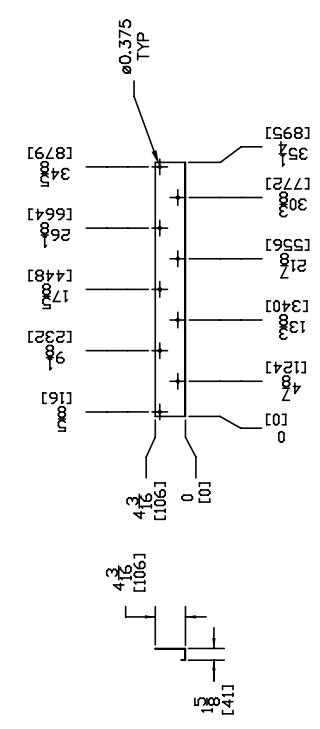

Dimensional Data - AVPA30/36, and HVEA24 ComPac® I & II Air Conditioners

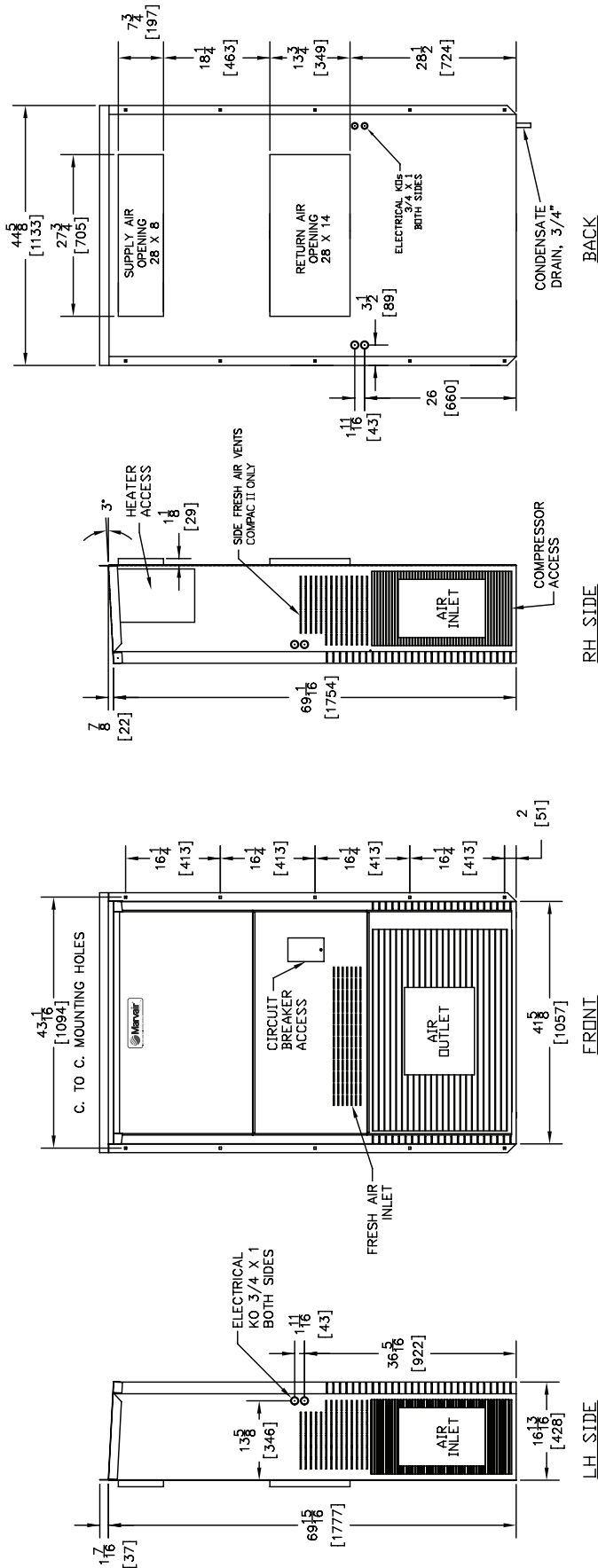

Shipping Weight (pounds/kilograms)

AVPA30/36 & HVEA24	LBS/KGS
COMPAC I	355/160
COMPAC II	375/170

Filter Size

AVPA30/36 & HVEA24	INCHES	MILLIMETERS	PART NUMBER	FILTERS PER UNIT	MERV RATING
RETURN AIR FILTER	30 x 16 x 2	762 x 406 x 51	80138	1	7

BOTTOM MOUNTING BRACKET

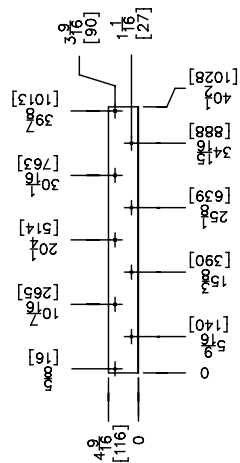

Dimensional Data - AVPA42/48/60, and HVEA30/36/42, HVESA30/36/42 ComPac® I & II Air Conditioners

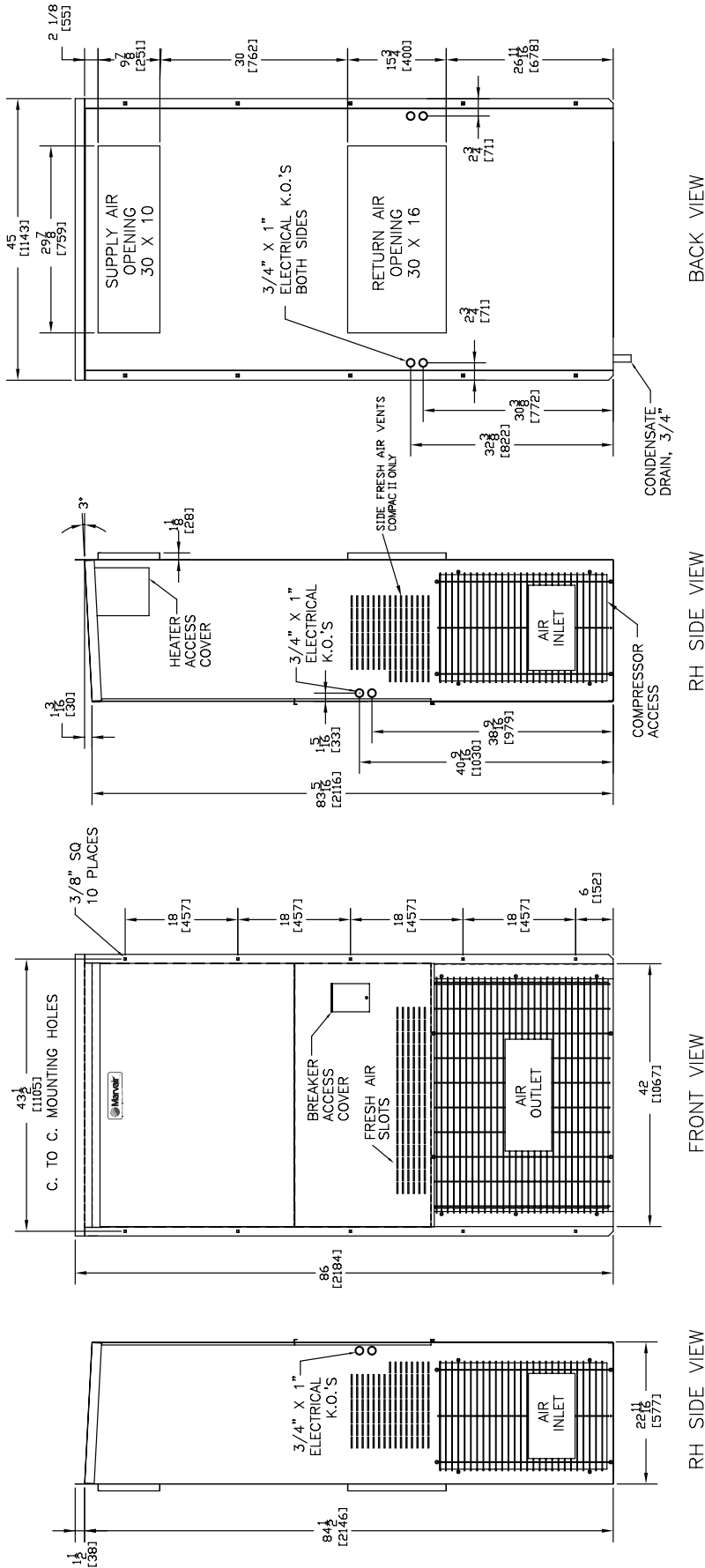

Shipping Weight (pounds/kilograms)

AVPA42/48/60 and HVEA30/36/42, HVESA30/36/42	LBS/KGS
COMPAC I	535/245
COMPAC II	590/268

Filter Size

AVPA42/48/60, HVEA30/36/42, & HVESA30/36/42	INCHES	MILLIMETERS	PART NUMBER	FILTERS PER UNIT	MERV RATING
RETURN AIR FILTER	36 1/2 x 22 x 2	927 x 559 x 51	80162	1	8

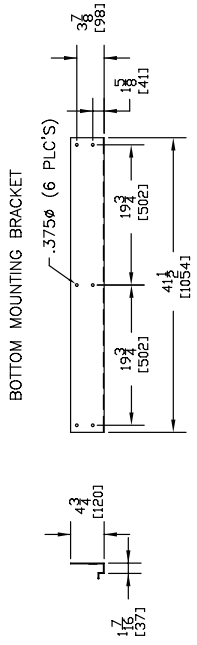

Dimensional Data - AVPA72, and HVEA49/60, HVESA49/60 ComPac® I & ComPac® II Air Conditioners

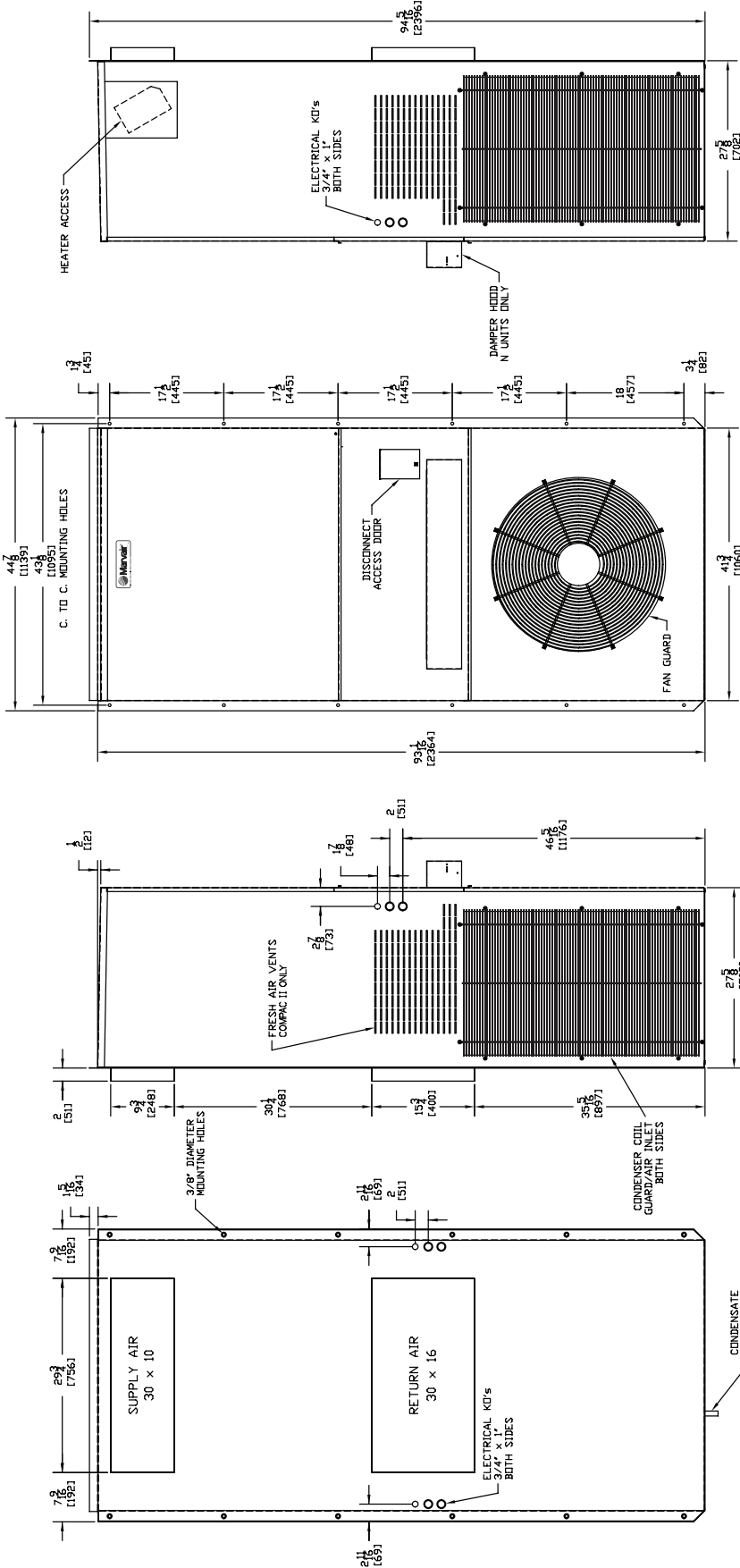

RH SIDE VIEW

FRONT VIEW
COMPRESSOR ACCESSED FROM FRONT

LH SIDE VIEW

REAR VIEW

Shipping Weight (pounds/kilograms)

	LBS/KGS
AVPA72, and HVEA49/60, HVESA49/60	625/284
COMPAC I	640/291
COMPAC II	

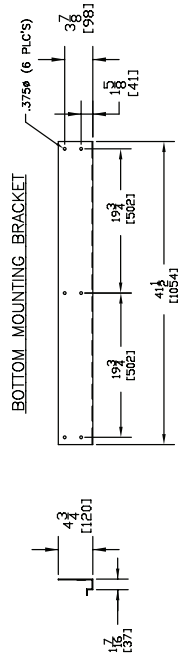

Filter Size

AVPA72, HVEA49/60 & HVESA49/60	INCHES	MILLIMETERS	PART NUMBER	FILTERS PER UNIT	MERV RATING
RETURN AIR FILTER	18 x 24 x 2	457 x 610 x 51	81257	2	7

Dimensional Data - AVPA60 with K/04315 Back Panel

For matching existing AVP36 wall opening with new AVPA60

MODEL	A	B	C	D	E	F	G	H	I	J	K	L	M	N	O	P	Q
60 (inches)	45	22-5/8	86	8	18	14	42-1/2	28	1-5/16	40-9/16	38-9/16	1-1/8	43-1/8	42-3/16	40-1/2	2-1/4	83-5/16
60 (mm)	1143	575	2184	203	457	356	1080	711	33	1030	980	29	1095	1072	1029	57	2116

NOTE: Dimensional tolerance $\pm 1/16"$ (2 mm)

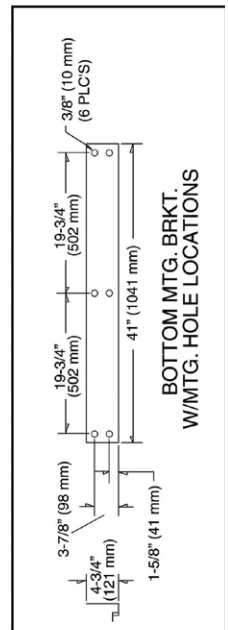
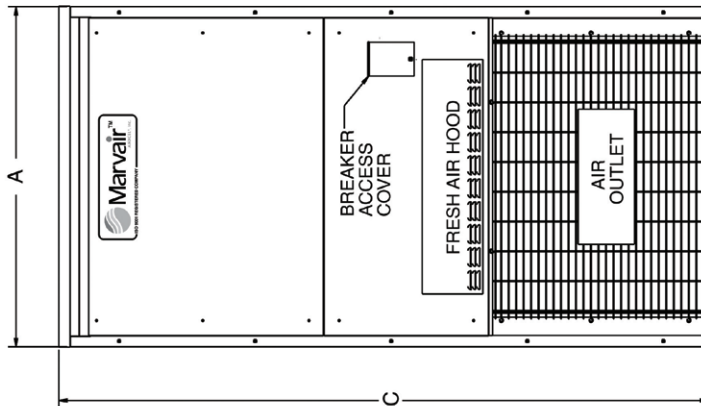
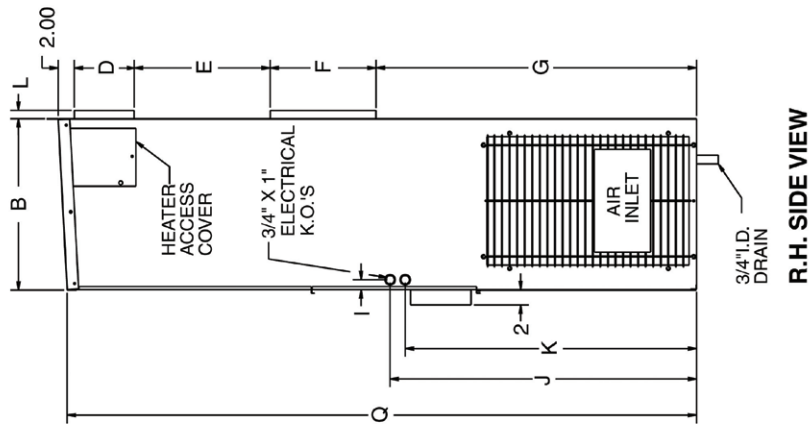
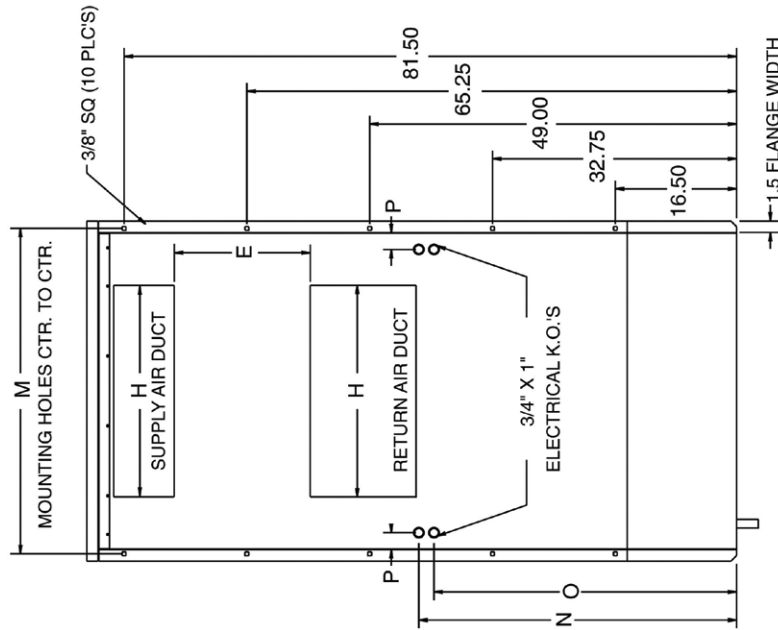

Dimensional Data - AVPA60 with K/04317 Back Panel
 For matching existing AVP24 wall opening with new AVPA60

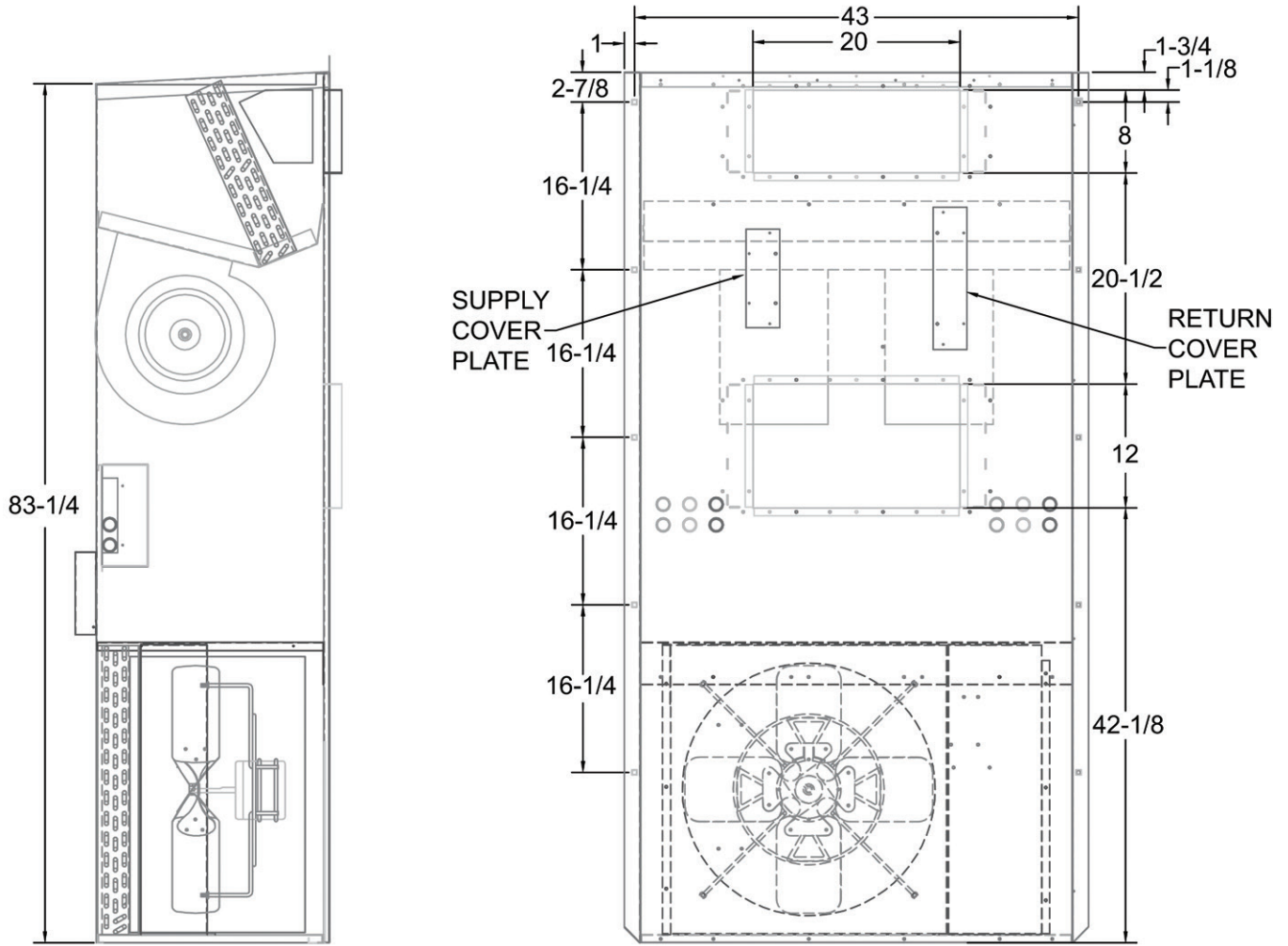

NOTES:

UNIT IS SHIPPED FROM THE FACTORY WITH SUPPLY AND RETURN LINES CENTERED LEFT TO RIGHT ON BACK PANEL. RETURN AND SUPPLY OPENINGS MAY BE SHIFTED 2-9/16" LEFT OR RIGHT TO ALLOW FOR A BETTER FIT. A SLOTTED HOLE PATTERN IS PROVIDED TO ASSIST WITH CUT OUT OF OPENINGS AND COVER PLATES ARE ALSO PROVIDED TO COVER EXCESSIVE HOLES LEFT IN BACK PANEL AFTER MAKING CUT OUTS.